

London Electronics Limited

Panel mounting count/rate meter

Model INT4-C

Installation & Operating Manual



- ✓ Easy setup
- ✓ Accepts NPN, PNP, contact, 5V, 24V pulses
- ✓ Display = 3, 4, 5 or 6 digits (configurable)
- ✓ Optional Output 4-20mA / 0-10V isolated
- ✓ Optional Alarm output = 2 or 4 relays
- ✓ Optional Comms Output = RS232 or RS485
- ✓ 110-230V AC or 11-30V DC power

Caution: There is a risk of electrical shock if this instrument is not properly installed



Caution: Risk of danger: Read the whole manual before you install this meter



Software version F04.01

Revision:1
Dated: 1 May2016

Warranty

We warrant our products against defects in materials or workmanship for a period of three (3) years from the date of purchase.

In the event of a defect during the warranty period, the unit should be returned, freight (and all duties and taxes) prepaid by the Buyer to the authorised distributor from where the unit was purchased.

The Distributor, at its option, will repair or replace the defective unit. The unit will be returned to the Buyer with freight charges prepaid by the distributor.

LIMITATION OF WARRANTY

The foregoing warranty shall not apply to defects resulting from:

1. Improper or inadequate maintenance by the buyer.
2. Unauthorised modification or misuse.
3. Operation outside the environmental specification of the product.
4. Mishandling or abuse.

The warranty set forth above is exclusive and no other warranty, whether written or oral is expressed or implied. We specifically disclaim the implied warranties of merchantability and fitness for a particular purpose.

EXCLUSIVE REMEDIES

The remedies provided herein are the buyer's sole and exclusive remedies.

In no event shall we be liable for direct, indirect, incidental or consequential damages (including loss of profits) whether based on contract, tort or any other legal theory.

Ordering code: **INT4-C-X-X-X-X-X-X**

INT4 = Intuitive Mark 4 family
C = Pulse Input model
Analogue output: — **0**=none, — **ANB**=-10to+10V, — **ANI**=4-20mA, — **ANV**=0-10V
Alarm outputs: — **0**=none, — **AL2**= 2 relays, — **AL4**=4 relays
Serial data: — **0**= none, — **232**=RS232, — **485**=RS485
Display colour: — **R**=Red, — **G**=Green
Power: — **AC**=100-240V AC, — **DC**=11-30V DC
Mounting: — **0** = Standard panel **DIN** = DIN rail mounting

Contents

Warranty	2
Warnings	4
Introduction	5
General Description	6
Panel mounting & Installation - Class II	7
DIN Rail mounting option	8
Other Mounting options	9
Wiring Advice	10
Connections	11
Installation hints for best performance	12-13
Application Notes	14
Display Brightness	15
Input Signal Configuration	16
Input Signal Configuration guide	17
Display Modes	18
Factory Defaults	19
Simple Rate mode	20-21
Period Mode	22-23
Totalising Modes	24-25
Production Rate mode	26-27
Quadrature mode	28-29
Logic Input functions	30
Logic Input connections and front buttons	31
Notes	32-33
Last Digit rounding	34
Scale Factor adjustment	35
Offset Adjustment	36
Menu Timeout adjustment	37
Reverse / Mirror display setting	38
Bootup Routine choices	39
Language selection for user interface	40
Multi Memory MEM option	41
Error Codes	42
Output Options - installing	43
WEEE	44
Equipment Specifications	45
Record of Revisions	46
Declaration of Conformity	47

Separate manuals for options

Alarm option settings	See Alarm manual *
Analogue output option settings	See Analogue manual *
Serial output option settings	See Serial manual *
Real Time Clock setting	See Serial manual *

* Need a manual urgently?
You can download manuals from our website.

Warnings

Please carefully read this manual and all warnings. Install the meter ONLY when you are sure that you've covered all aspects.



Where the product is intended for "UL" installations, removal or addition of option boards is not permitted.



Check that the model number and supply voltage suit your application before you install the meter.



Connect the meter according to current IEE regulations, IEC61010 & NFPA:70 National Electric Code in USA.



This meter is for Installation class II service only. This means it has exposed electrical and power terminals. You must install it in a suitable fire enclosure which will also protect users from electric shock



We designed this meter for Pollution-Degree 2 environments only.



Power supplies to this equipment must have anti-surge (T) fuses rated at 400mA for 230V supply, 400mA for 110V supply or 2A for DC supplies in the range 11-30VDC. Only Siba fuses in series 189500, cULus listed according to file #E167295 are accepted for this service under the terms of UL listing. A switch or circuit breaker, clearly marked as a disconnecting device, must be included close to the installation.



Don't touch any circuitry after you have connected the meter, because there may be lethal voltages on the circuit board.



Only adjust on-board switches or connections with the power turned off



Make sure all screw terminals are tight before you switch the meter on.



Only clean the meter's front with a soft damp cloth. Only lightly dampen with water. Do not use any other solvents. The behind-panel case may be cleaned with a dry cloth only, use no liquid or solvent on it.

**Safety FirstDon't assume anything..... Always double check.
If in doubt, ask someone who is QUALIFIED to assist you in the subject.**

Introduction

Please contact us if you need help, if you have a complaint, or if you have suggestions to help us improve our products or services.

If you contact us about a product you already have, please tell us the full model number and serial number, so that we can give you accurate and fast help.

This product has a 3 year warranty. We will put right or replace any meter which is faulty because of bad workmanship or materials. This warranty does not cover damage caused by misuse or accident.

If you return a unit for repair, please include a detailed description of the problem, and the name of a contact who we can refer to for any questions. Please mark for the attention of the QA Department.

IMPORTANT

If this equipment is important to your process, you may want to buy a spare to cover possible failure or accidental damage in the future.

This is because during factory shutdown periods, you may have to wait several weeks for an equivalent replacement, or we may have no stock at the time you urgently need it.

You may also need to pay extra carriage charges if you want a fast, guaranteed courier service. Warranty repairs or replacements are usually returned with a standard courier service.

We do not offer compensation for losses caused by failure of this instrument.

If you do not agree with these conditions, please return this item in unused, condition, in its original packaging and we will refund the purchase price, excluding any carriage paid.

We thought you'd prefer to know about possible delays and extra charges now, rather than during a panic. A spare unit could help to avoid these issues.

We always try to improve our products and services, so these may change over time. You should keep this manual safely, because future manuals, for new designs, may not describe this product accurately.

We believe these instructions are accurate, and that we have competently designed and manufactured the product, but please let us know if you find any errors.

General Description

This series of meters accepts industrial sensors to allow various physical measurements to be made, such as weight, temperature, pressure, humidity etc. Different models are available for different sensor types.

The main function of this series is to give a numeric readout of the variable being monitored. Most models include an excitation power output, to power the sensor directly.

Various optional output modules are also available to give alarm relay outputs, analogue output or digital communications, or any combination of these options.

Meters are programmed using front panel pushbuttons. The buttons may be locked with a rear switch.

Meters have two power supply options : 100-240 VAC or 11-30VDC

These meters are designed to mount into a protective enclosure which will protect users from contact with power and signal wiring.

These units must be installed fully assembled, and must be installed according to local electrical installation rules. When properly installed, they provide ingress protection to IP65 / NEMA4X from the front

Safety



Caution: There is a risk of electrical shock if this instrument is not properly installed



Caution: Risk of danger: Read the whole manual before you install this meter

Obey all safety warnings in this manual, and install the meter according to local wiring and installation regulations. Failure to follow these guidelines may cause damage to the meter, connected equipment, or may be harmful to personnel.

Any moving mechanical device controlled by this equipment must have suitable access guards to prevent injury to personnel if the meter should fail.

Panel Mounting and Installation - Class II

Install the meters in a suitable protective electrical control enclosure according to local wiring regulations. See specifications for maximum allowable temperature in enclosure. Allow adequate air circulation.

Installing into front of panel
Remove the two rear bracket screws and safely store them and the U-Bracket for later fitting.

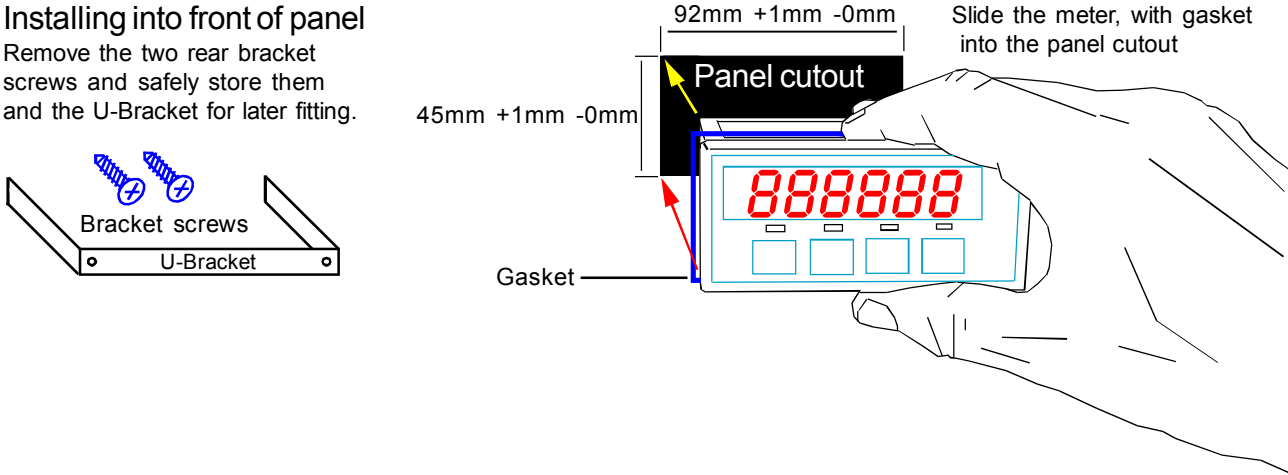

Slide the meter, with gasket into the panel cutout

92mm +1mm -0mm
45mm +1mm -0mm

Panel cutout

Gasket

Bracket screws
U-Bracket

Securing into the panel
Re-fit the U-Bracket and tighten the bracket screws to firmly clamp the meter in place. Check that the gasket is evenly pinched between the meter's front bezel and the enclosure front

Ventilation
There should be sufficient ventilation in the enclosure to ensure that the meter's case is always kept to less than 60C.

Meter Spacing.
Meters should be spaced apart sufficiently to allow a free flow of ventilation air around the meters, such that no part of the case will exceed 60C

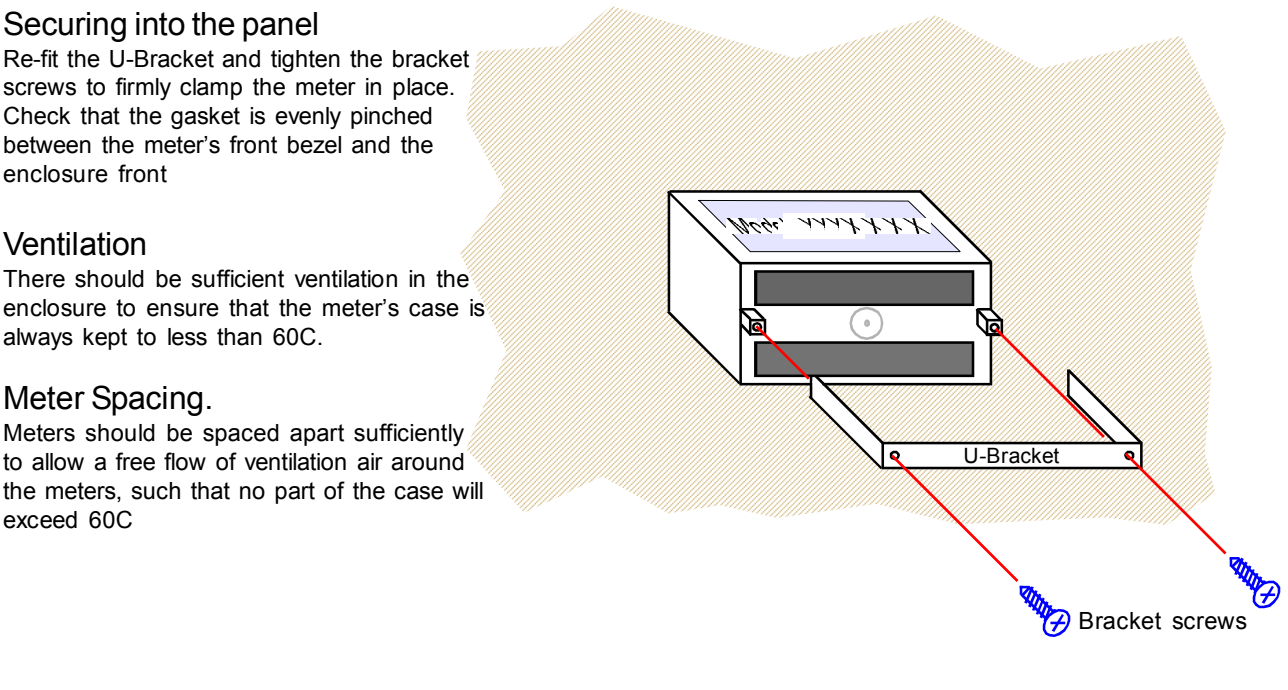

U-Bracket

Bracket screws

Side view of meter installed in panel

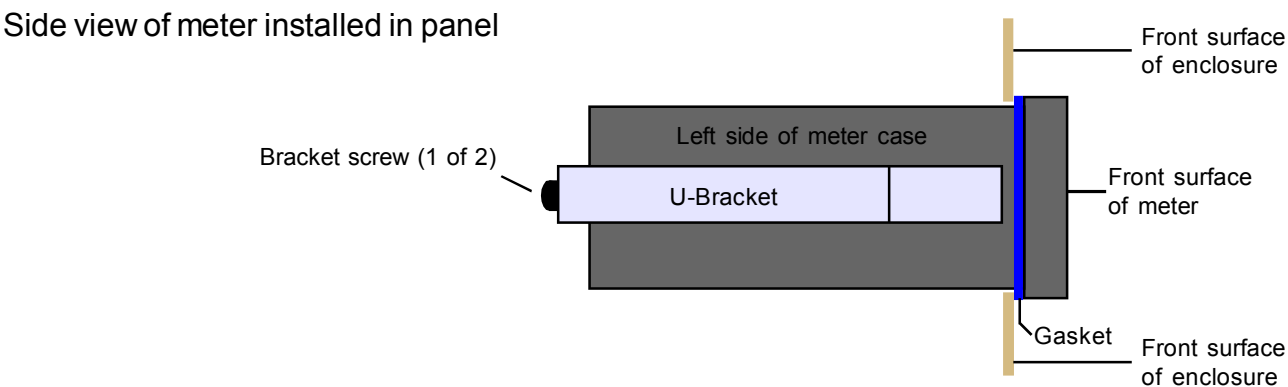

Bracket screw (1 of 2)

Left side of meter case

U-Bracket

Front surface of enclosure

Front surface of meter

Gasket

Front surface of enclosure

DIN Rail Mounting option

This Series is ideal if you need high precision signal conditioning. Sometimes, it is not necessary to have front panel indication, so in such cases, we offer a DIN rail mounting option, which allows the meter to be installed within a control panel.

Detachable connectors add to the simplicity of installation, and of course the setup method is identical to the panel mounting version, so you don't need to learn a new method.

The display remains active, so you can see at a glance the status of your signals, and programming is simple, using the 4 buttons.

Output functions include isolated 16 bit 4-20mA, 0-10V, -10 to +10V, RS232, RS485 and up to 4 alarms with a wide choice of alarm functions.

Install the meters in a suitable protective electrical control enclosure according to local wiring regulations. See specifications for maximum allowable temperature in enclosure. Allow adequate air circulation.

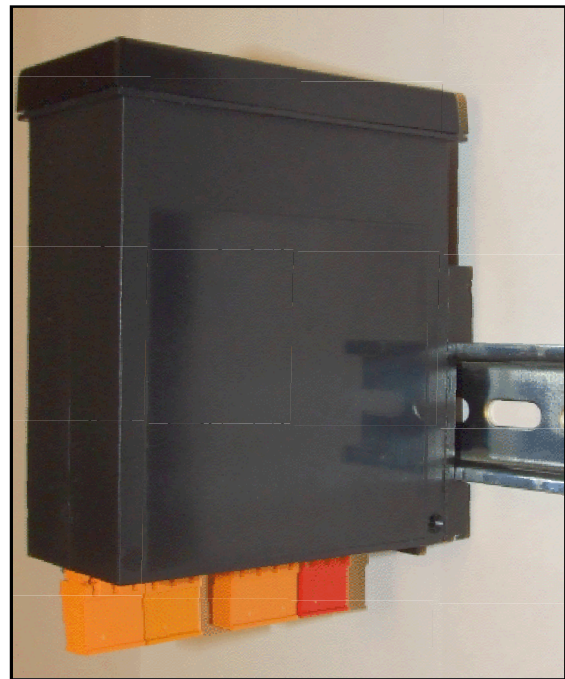

Securing into the panel

Use standard top-Hat DIN rail 35 mm x 7.5 mm (EN 50022, BS 5584, DIN 46277-3)

Ventilation

There should be sufficient ventilation in the enclosure to ensure that the meter's case is always kept to less than 60C.

Meter Spacing.

Meters should be spaced apart sufficiently to allow a free flow of ventilation air around the meters, such that no part of the case will exceed 60C

Other mounting options

IP67 SPC4

The SPC4 splashproof cover gives IP67 / NEMA4-X protection for the front of your meter. Ideal for use in harsh wet environments.

Available with optional security tag ports to allow you to fit your own crimped wire tamper-seals, to prevent or indicate unauthorised access (Similar to tags used on electricity meters)

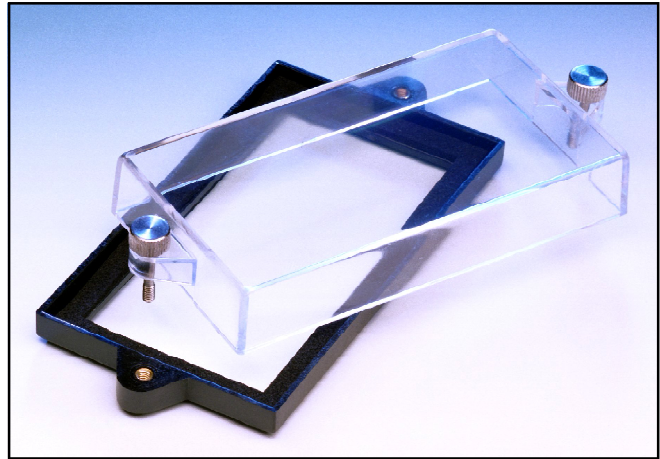

Wall Box

The Wallbox is sealed IP65 all round, and is supplied with the meter installed, for you to wire to, via 3 cable glands. It comes complete with SPC4 splashproof cover.

We also offer a dual version of this enclosure, which can take 2 meters, one above the other.



PCC Series

The PCC series of Portable Carrying cases is ideal for housing your panel meters so that they can be used in the lab. These enclosure come fully wired, with panel meters fitted and with IEC switched power connector plus any input or output connectors, as required.

Versions are available to accept 1, 2, 4, 6, 8, 12 or 16 meters



Wiring Advice

This meter uses detachable screw terminal connectors. Refer to the wiring diagram on the following page for the correct positioning of each wire.

The conductors you use must be suitable for the meter's temperature, current and voltage rating, which is broadly described as follows:-

Cable Temperature Rating

All cables must be rated for operation up to 90C continuous.

Cable gauge and screw tightness

The connectors on this instrument can accept conductors up to 16 gauge AWG / 1.5mm² c.s.a. The minimum cross sectional area shall be 22 gauge AWG / 0.5mm². Tighten screw terminals to 7.0 lb/in torque / 0.8 Nm torque.

Cable insulation voltage rating

Cables shall have an insulation voltage rating of at least 380V continuous.

Wire preparation:

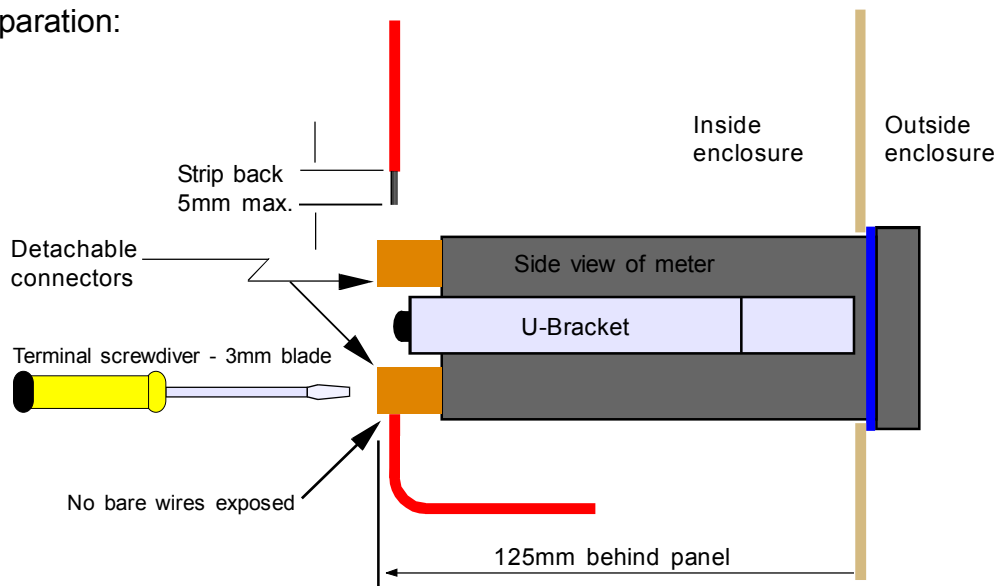

We recommend multi-strand wire, because it withstands vibration better than single strand cable. Pull the wire firmly after you make the connection to confirm it is tight.

Use screened cable for all signal and control wiring and connect the screen to earth at the destination end only. Route signal cabling away from power cabling and relay switching cabling, to avoid electrical noise interference.

Connections

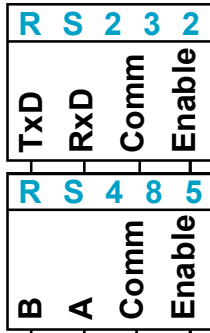

Enable is used in mode C1 to activate or de-activate the RS232 or RS485 serial output. Connect to Comm to continually transmit data.

Connectors and options
Connectors may be present even if output options are not installed. Refer to rating label to see installed options.

Rated 2A 250VAC Resistive
AL1 AL2 AL3 AL4

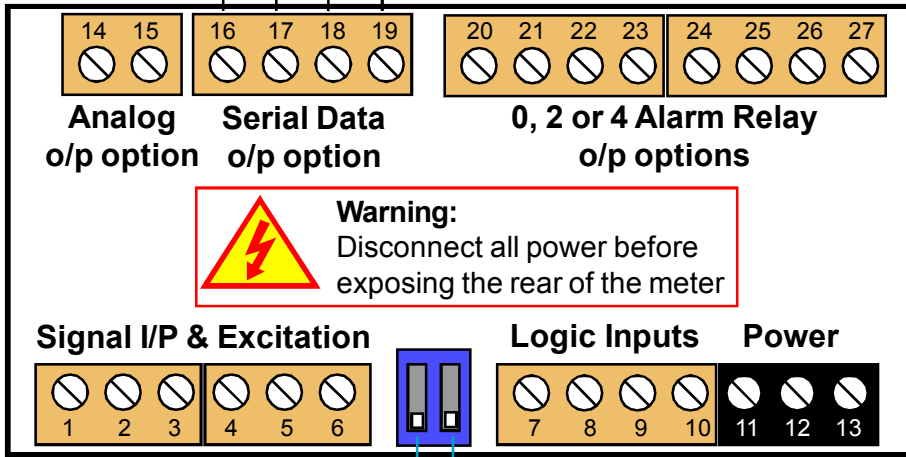

Warning: Disconnect all power before exposing the rear of the meter

Class II Installation

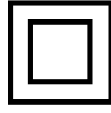

Customer-supplied disconnection and overload protection devices

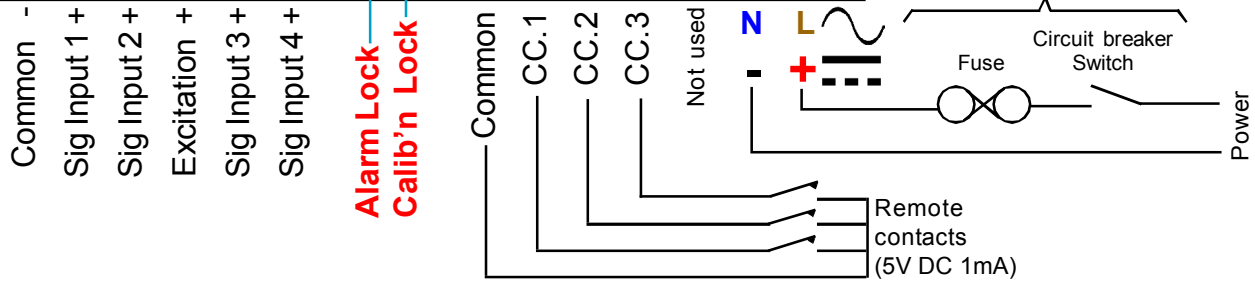

Installation hints for best performance

This section offers several suggestions which will help you get the best performance from your measurement system.

Some sensors generate comparatively small signals which can easily be corrupted by the potentially high level of electrical noise which can be created by electrical machinery such as motors, welding systems, discharge lighting, AC power inverters and solenoids. These steps will ensure you get the best possible performance from your system.

1. Use good quality screened signal cable, with twisted pairs. Belden 8777NH, Belden 9503 and AlphaWire 6010C are good choices, available from many electrical distributors.
2. If you are using multi-pair twisted cable, each pair should be dedicated to a single display as shown opposite, for maximum noise immunity. This will ensure that any electrical noise induced in the cable is properly cancelled. Mixing destinations carelessly amongst the twisted pairs can actually worsen noise performance.
3. The cable should be routed away from noisy wiring and devices such as power feeds from inverters, discharge-lighting cables, welder cabling etc, and should preferably be routed in a dedicated low voltage signalling/instrumentation conduit or cable tray.
4. Screened cable should be earthed at the display end only.
5. All wires and screens coming out of the screened cable should be kept as short as possible to minimise pickup of noise.
6. If you are using barriers, you should earth your screen as shown below, paying particular care that you do not earth both ends of any run of of cable.

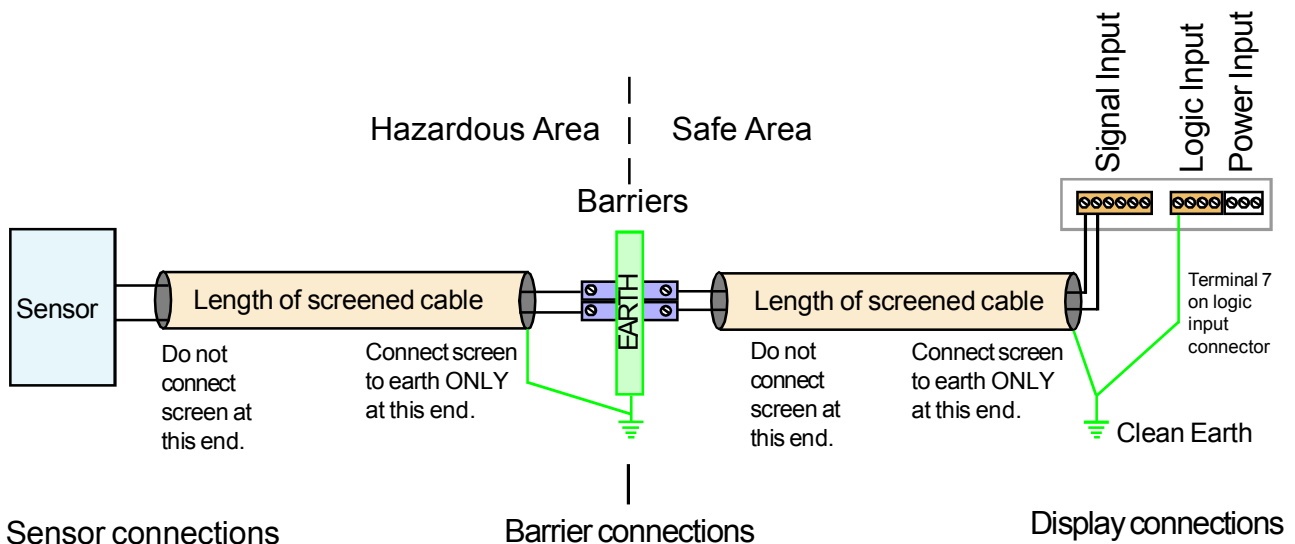

When using multi-core screened cable to connect several displays to several sensors, please be sure to use one twisted pair for each display and sensor.

Do NOT use a wire from one pair for signal positive and a wire from another pair for signal negative, as this will prevent the twisted cables from cancelling any induced electrical noise, and can couple noise from one channel to another.

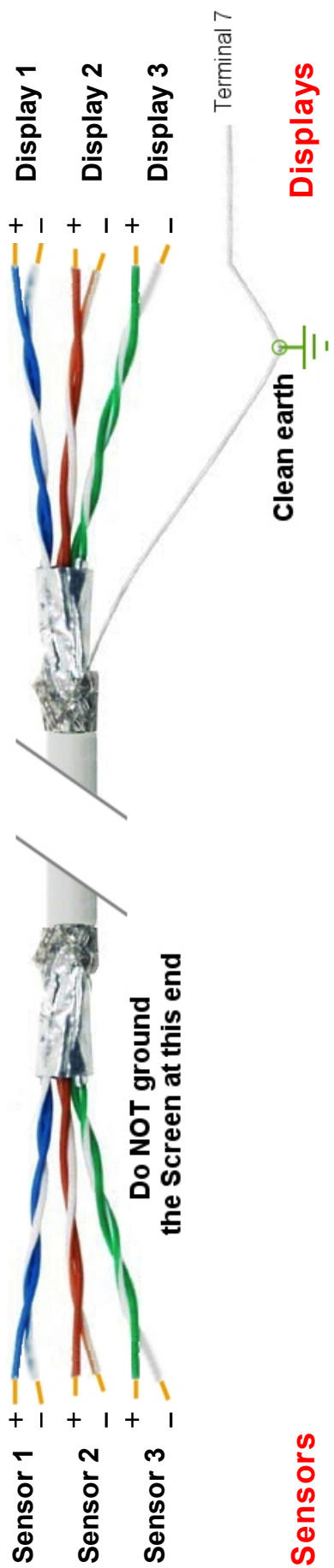

Application Notes

Display Brightness

You can adjust the display brightness at any time, provided the display is locked.

1

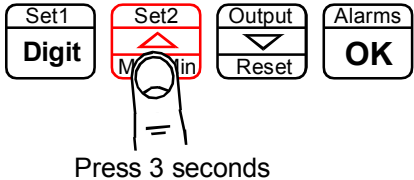

Set1 Digit Set2 Output Alarms
M in Reset OK

Press 3 seconds

Lockout Switch must be ON

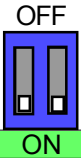

Circuit board ON

2

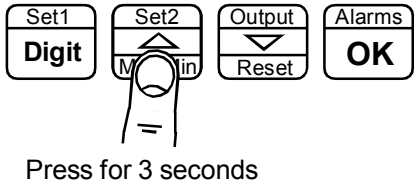

Set1 Digit Set2 Output Alarms
M in Reset OK

Press for 3 seconds

Display shows **br 9ht**
Each press of the UP button will select a new brightness level. There are 7 brightness levels to choose from.
(Default = Full brightness)

3

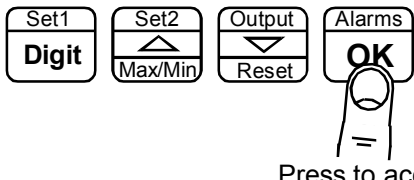

Set1 Digit Set2 Output Alarms
Max/Min Reset OK

Press to accept



Done!



Did you know, we make this display in two brightness versions? Standard brightness for use inside, and Daylight Viewing for use outside in direct sunlight. The Daylight Viewing version has suffix -DLV in its part number.

Input signal configuration

Each of the display's 4 inputs can be configured to accept different types of input signals, using the procedure below....

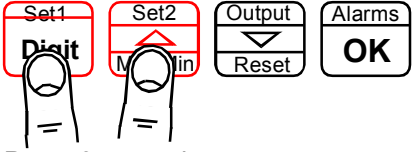
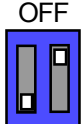
1  **Lockout Switch must be OFF** 

Press 3 seconds Circuit board ON

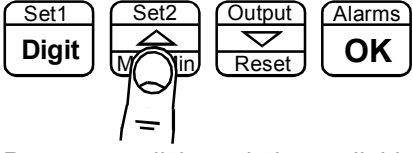
2  **Display shows input channel choices...**

Press to scroll through the available input channel choices and press OK to select.

InP 1	Input 1
InP 2	Input 2
InP 3	Input 3
InP 4	Input 4

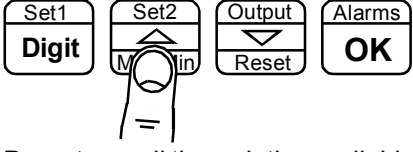
3  **Display shows input signal type choices...**

Press to scroll through the available signal type choices and press OK to select.

PULS.dc	DC pulses from 5 to 60V
Induct	Passive inductive sensors
PULS.AC	AC signals up to 60V

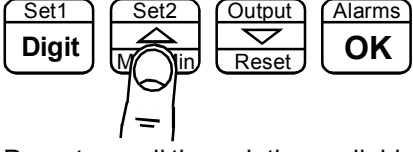
4  **Display shows input signal loading choices**

Press to scroll through the available signal loading choices and press OK to select.

NPN	Pull up resistor activated
PNP	Pull down resistor activated

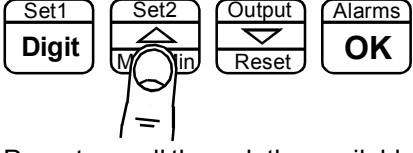
5  **Display shows input de-bounce choices...**

Press to scroll through the available debounce choices and press OK to select.

dbn.ON	Contact debounce active
dbn.OFF	Contact debounce inactive

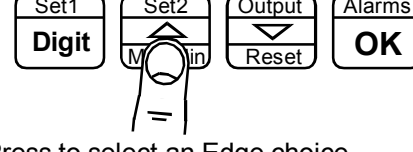
6  **Display shows edge count choices in the following modes:-**

Press to select an Edge choice then press OK to accept.

1in.u.d, 2in.u.d, 2in.u.u., 4 uudd, 4 uuuu, 4 dddd, quad.

Ed9.1	Count rising edge
Ed9.0	Count falling edge

✔ Done!

Input signal configuration guide

This table tells you which settings to choose for each input signal type. The sensor should be connected to the display according to the connection diagram page.

Sensor family	Input Signal Type	Input signal loading	Input de-bounce
Contact closure	PuLS.dc	NPN	dbn.ON
NPN	PuLS.dc	NPN	dbn.OFF
PNP/ Push-pull	PuLS.dc	PNP	dbn.OFF
TTL	PuLS.dc	NPN	dbn.OFF
CMOS	PuLS.dc	PNP	dbn.OFF
Passive coil	induct	PNP	dbn.OFF
AC Tacho	PuLS.AC	PNP	dbn.OFF

Excitation Output: 24VDC nominal rated at 60mA, to power sensors (standard)
 10V DC at 120mA Max (optional), 5V DC at 30mA max (optional)

Signal I/P & Excitation

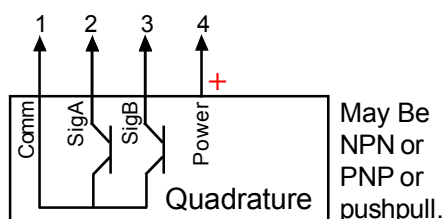
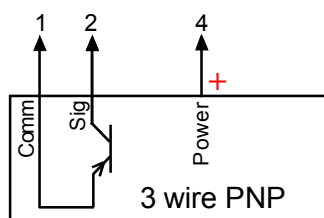
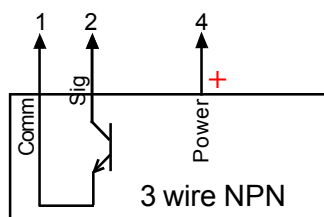
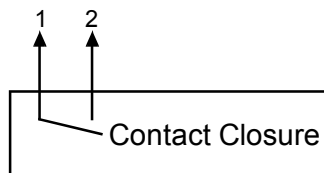
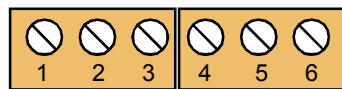

Signal I/P & Excitation

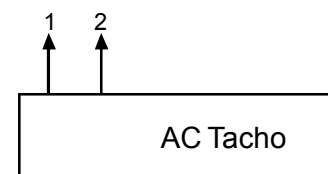
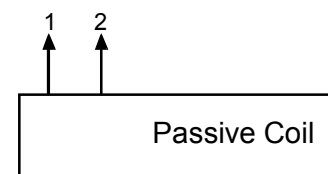
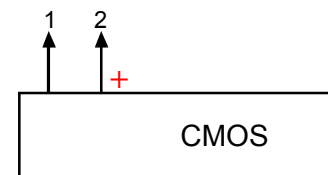
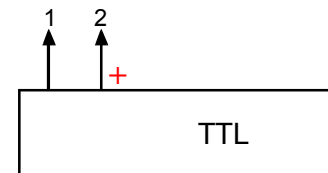
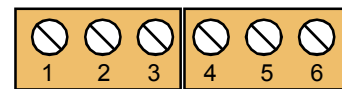

Display Modes

You can choose from eleven basic display modes, some of which have extra sub-modes.

1

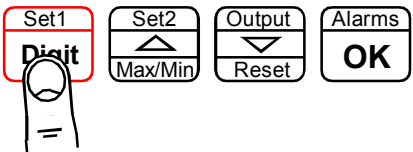

Press 3 seconds

Lockout Switch must be OFF

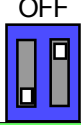

Circuit board ON

2

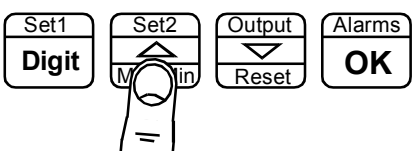

Press to scroll through the available mode choices.

Each mode has a separate section to describe its operation in detail.

When you have chosen a mode, press OK to select.

Display shows...

rAtE	Rate, Frequency, RPM
PERIOD	Intervals, bake time
total	Counting
gated	Gated counting
1 in. u.d.	1 input, Up/Down control
2 in. u.d.	2 in, Up/Down
2 in. u.u.	2 in Up, Up
4 uddd	4 in , Up, Up,. Down, Down
4 uuuu	4 in, Up, Up, Up, Up
4 dddd	4 in Down, Down, Down, Down
QuAd	Quadrature

3

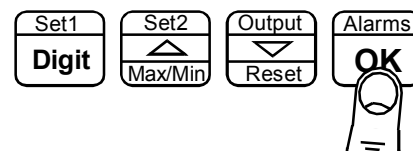

Press to accept

Done!

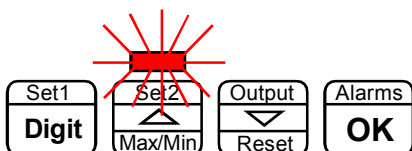
The LED above the Set 2 button will illuminate if your display is in one of the totalising modes, otherwise it is off.

Factory Defaults

You can return the display to its factory default conditions whenever you wish. If you do so, you will permanently lose all your settings and will need to start from the beginning again.

The calibration Audit Counter will NOT be reset, there is no way provided to reset this value, as it is intended as a secure record to indicate whether changes have been made to the display since it was last calibrated..

1

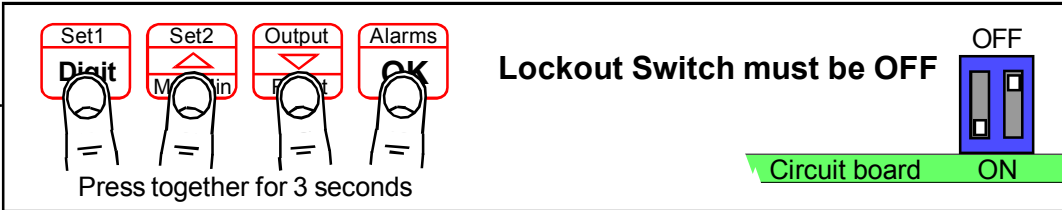

Press together for 3 seconds

Lockout Switch must be OFF

Circuit board ON

2

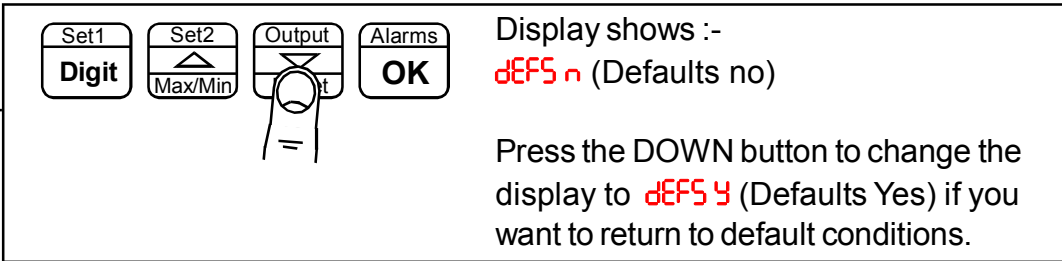

Display shows :-
dEFS n (Defaults no)

Press the DOWN button to change the display to dEFS Y (Defaults Yes) if you want to return to default conditions.

3

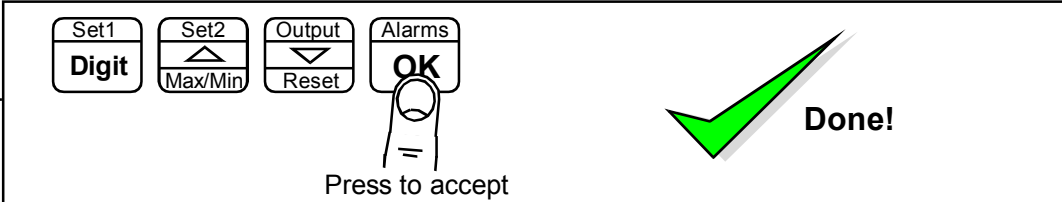

Press to accept

Done!

Calibration audit number

Your display includes a non-resettable counter which increments each time you make a change to the display's calibration. This is useful if you want to check whether a display has been altered since it was last calibrated.

The Calibration audit number starts at CAL 01 up to CAL FF allowing up to 255 alterations to be recorded. Whenever you want to check the calibration audit number, press and hold the 2 outer buttons (Set1 + Alarms) for more than 3 seconds.

1

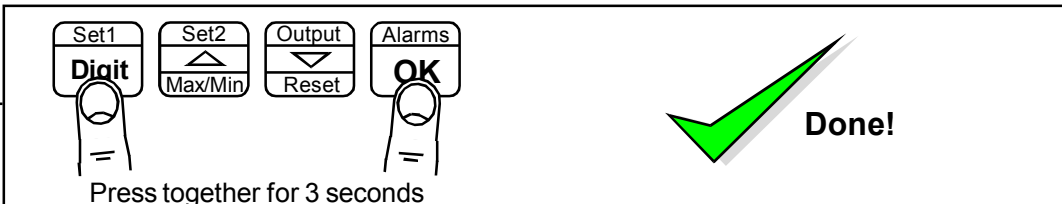





Press together for 3 seconds

Done!

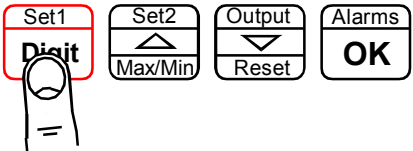
Simple Rate Mode

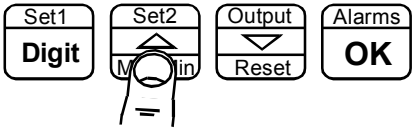
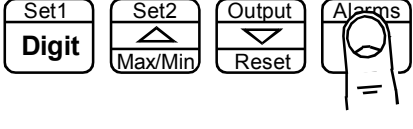
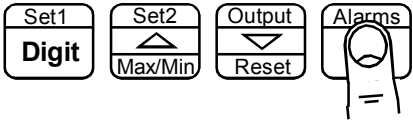
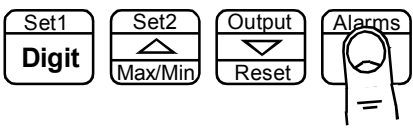
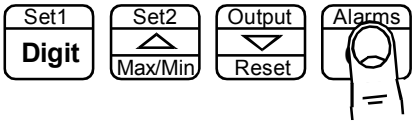
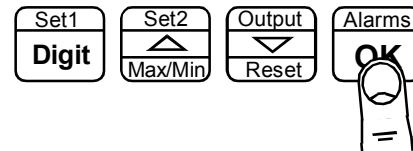
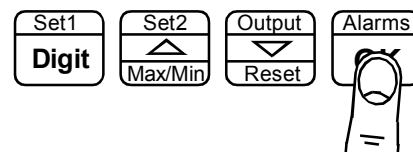
Rate mode is ideal for showing instantaneous speed, RPM, frequency, production rate, flow rate etc. For production rate showing the true number of items produced in the last hour, consider using our 'Production Rate Mode' method, which is ideal for production which is erratic or has periods of widely differing production rate.

1		<p>Lockout Switch must be OFF</p> 
	<p>Press 3 seconds</p>	<p>Circuit board ON</p>
2		<p>Press to scroll through the available mode choices. Select rAtE and press OK</p>
3		<p>FREQ will appear, prompting you to enter a frequency in hertz, which will correspond to a desired display value. Use Digit, Up and Down buttons to set, and press OK to accept.</p> <p>You can move the decimal point during setting by pressing the UP button for a few seconds, then repeatedly press to shift the position.</p>
4		<p>1.5P will appear, prompting you to enter a display value, which will correspond to the frequency you entered. Use Digit, Up and Down buttons to set, and press OK to accept.</p> <p>You can move the decimal point during setting by pressing the UP button for a few seconds, then repeatedly press to shift the position.</p>
5		<p>AVG. 00 will appear, prompting you to enter a number of readings to average over, from 00 to 99. The bigger the number, the smoother will be the display, but response to change will be slower.</p>
6		<p>DEL 03 will appear, prompting you to enter a delay time in seconds, so that if no pulses are received within this time, the display will revert to showing 0</p>
7		<p>TARGET will appear, prompting you to enter a target rate. If measured rate falls below this value, display will flash. To disable this feature, set the target to 0</p>
8		<p>Done!</p> 
	<p>Press to accept</p>	

Application notes - Rate Mode

RPM Measurements

We can accept any number of pulses per rotation, from 1 upwards.

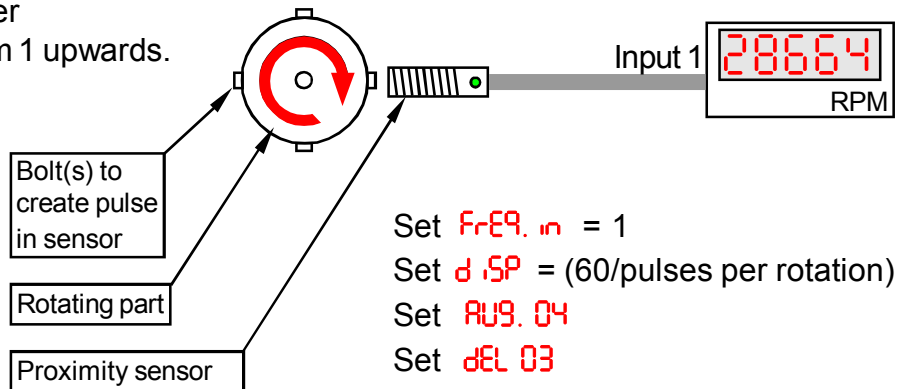

Frequency Measurements

Ideal for the precision measurement of generator or inverter grid frequency.

A simple step down transformer can be used to drop the line voltage down to a level suitable for the display.

5V to 30V AC is ideal.

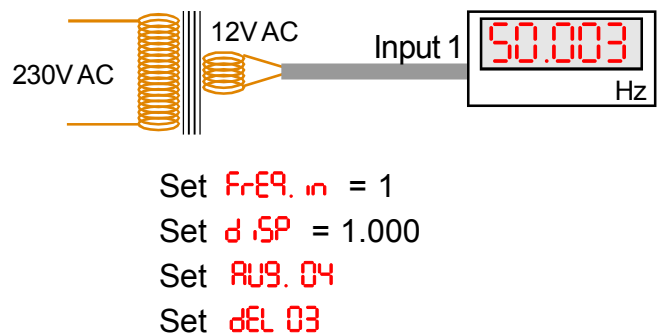

Flow rate Measurements

Accepts pulses from turbine flowmeters, positive displacement flowmeters.

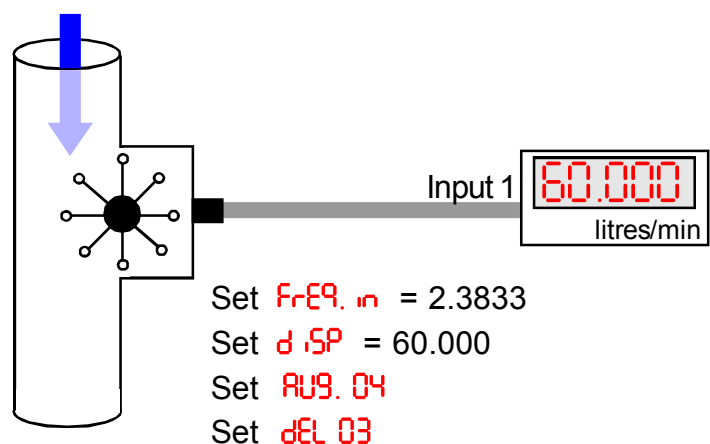

Has flexible scaling to suit any relationship between pulses per unit volume.

Example 143 pulses per litre, show litres per minute

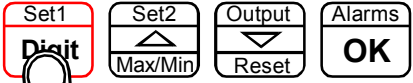
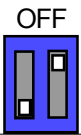
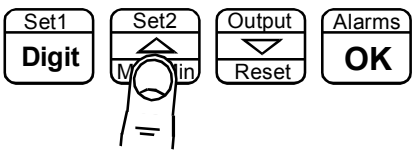
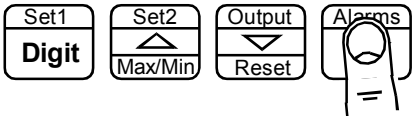
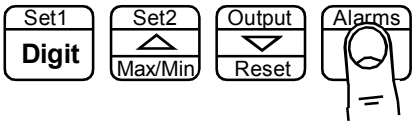
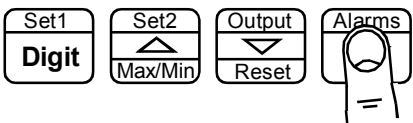
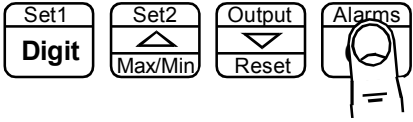
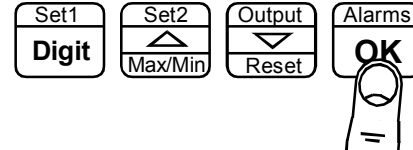

Period Mode

Rate mode is ideal for showing instantaneous speed, RPM, frequency, production rate, flow rate etc. For production rate showing the true number of items produced in the last hour, consider using our 'Binned Rate' method, which is ideal for production which is erratic or has periods of widely differing production rate.

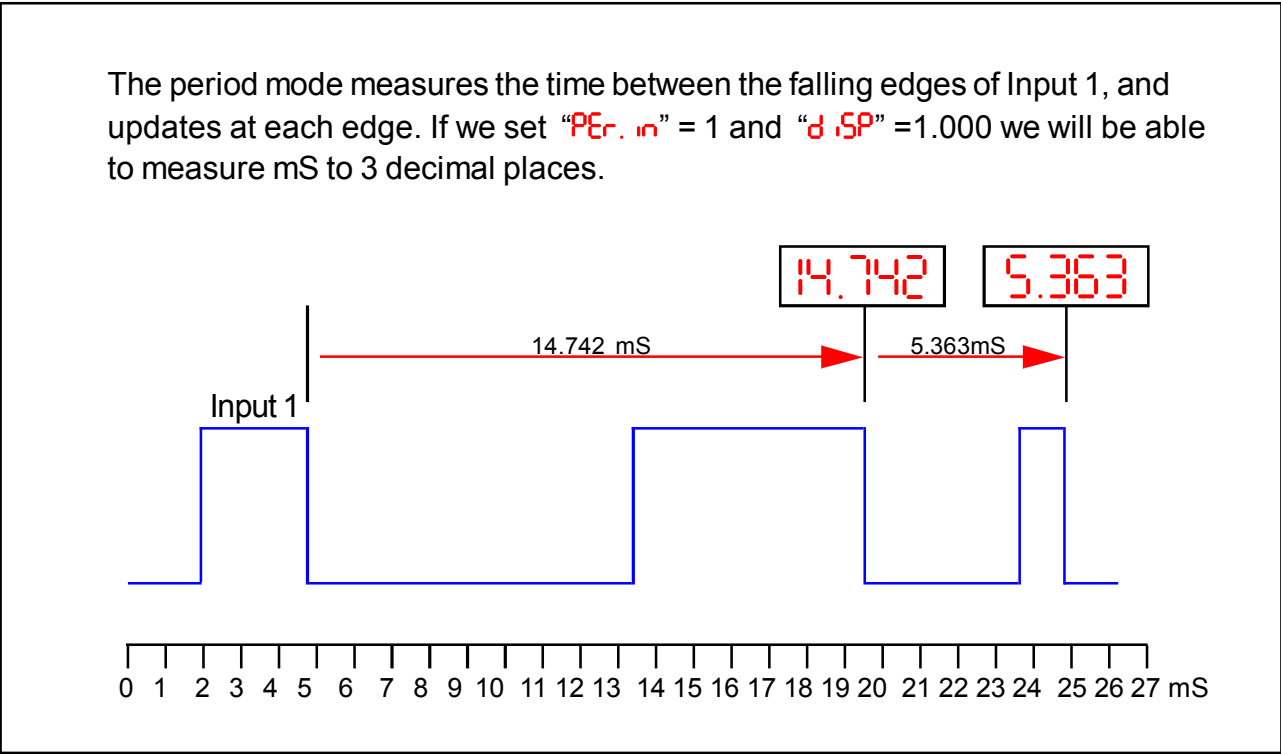
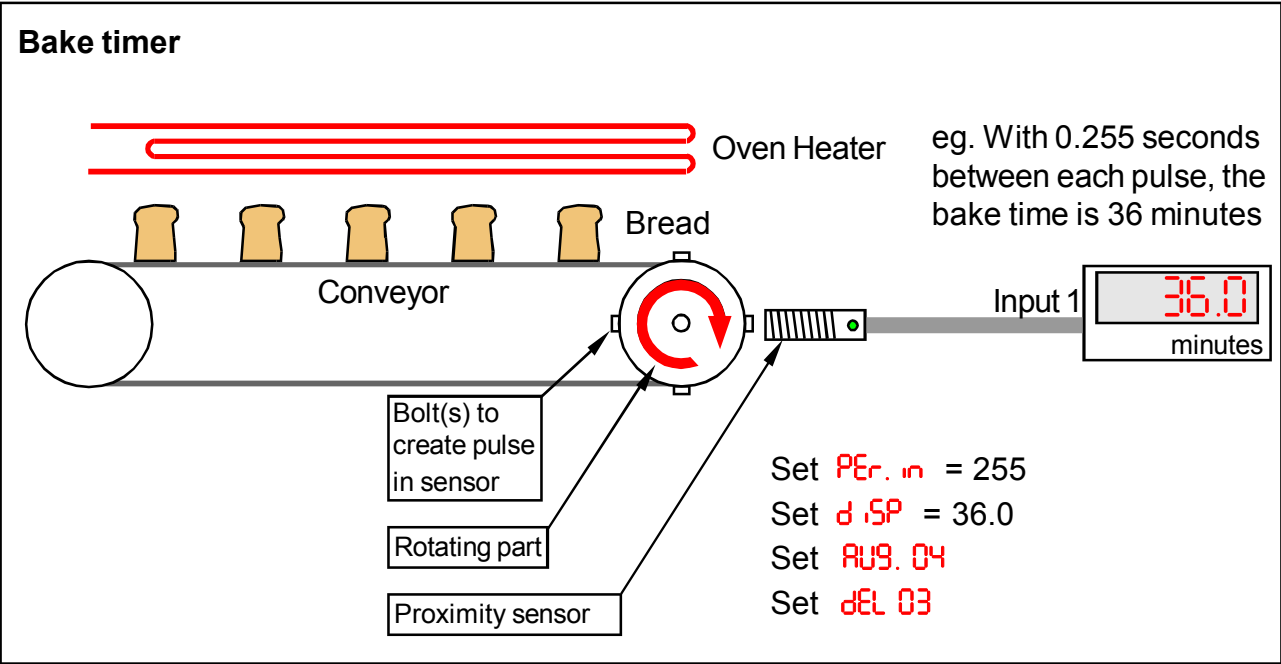

1	 <p>Press 3 seconds</p>	<p>Lockout Switch must be OFF</p>  <p>Circuit board ON</p>
2		<p>Press to scroll through the available mode choices. Select PERiod and press OK</p>
3		<p>PER.in will appear, prompting you to enter a period in milliseconds, which will correspond to a desired display value. Use Digit, Up and Down buttons to set, and press OK to accept.</p> <p>You can move the decimal point during setting by pressing the UP button for a few seconds, then repeatedly press to shift the position.</p>
4		<p>d.SP will appear, prompting you to enter a display value, which will correspond to the period in milliseconds you entered. Use Digit, Up and Down buttons to set, and press OK to accept.</p> <p>You can move the decimal point during setting by pressing the UP button for a few seconds, then repeatedly press to shift the position.</p>
5		<p>Av.00 will appear, prompting you to enter a number of readings to average over, from 00 to 99.</p>
6		<p>dEL.03 will appear, prompting you to enter a delay time in seconds, so that if no pulses are received during this time, the display will revert to 0</p>
7	 <p>Press to accept</p>	 <p>Done!</p>

Application notes - Period Mode

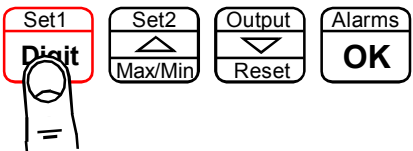
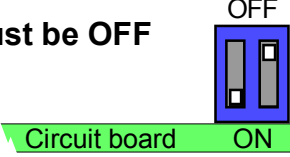
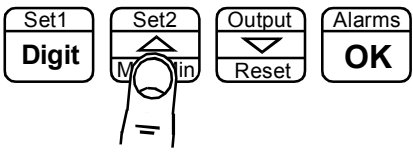
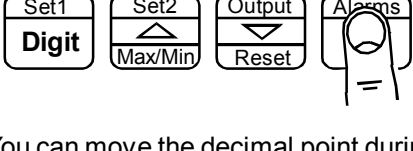
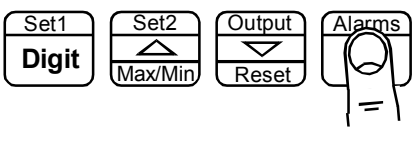
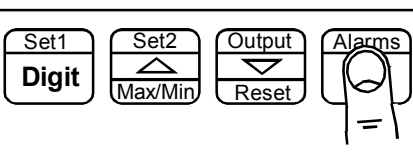
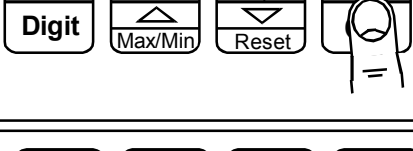

Totalising Modes

There are several useful totalising modes available, which use 1 or more of the display's logic input ports. The total will be stored on loss of power, and will be restored when power is returned to the display.

1	 <p>Press 3 seconds</p>	<p>Lockout Switch must be OFF</p> 
2		<p>Press to scroll through the available mode choices. Choose from these modes (described opposite)</p> <p>totAL, gAtEd.t, 1 in u.d, 2 in. u.d., 2 in. u.u., 4 uudd, 4 uuuu, 4 dddd</p>
3		<p>PuLS in will appear, prompting you to enter a number of input pulses, which will correspond to a desired display value. Use Digit, Up and Down buttons to set, and press OK to accept.</p> <p>You can move the decimal point during setting by pressing the UP button for a few seconds, then repeatedly press to shift the position.</p>
4		<p>d.SP will appear, prompting you to enter a display value, which will correspond to the number of input pulses you entered. Use Digit, Up and Down buttons to set, and press OK to accept.</p> <p>You can move the decimal point during setting by pressing the UP button for a few seconds, then repeatedly press to shift the position. A negative value will give down counting.</p>
5		<p>PrESEt will appear, prompting you to enter a reset value. The display will revert to this value whenever it is reset. Often used to count down from the preset to 0.</p>
6		<p>Pr.LoAd will appear, prompting you to enter a value, if required. You can preload a count number here. This value will disappear if you reset the display.</p>
7	 <p>Press to accept</p>	 <p>Done!</p>

Totalising modes - application notes

The 8 totalising modes are ideal for counting pulses, where 1 pulse = 1 item, or the total can be scaled, for example to show total flow of liquid, where 1 pulse may represent a certain volume of liquid according to the relationship between "PULS in" and "d,SP"

total

Totaliser (simple)

Pulses on input 1 are counted and scaled.

Signal I/P & Excitation

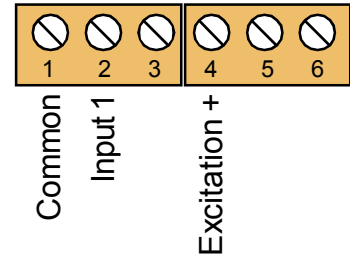

GATED.t

Gated Totaliser

Pulses on input 1 are counted and scaled, provided Input 2 is low. When input 2 is held high, pulses on Input 1 are ignored.

Signal I/P & Excitation

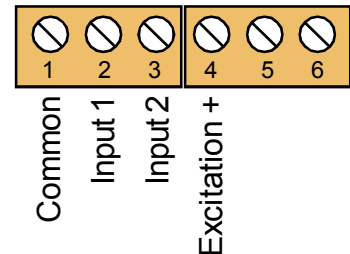

1 in u.d

1 input, Up/Down totaliser

Pulses on input 1 are counted and scaled. When input 2 is held high, pulses on Input 1 are added. When input 2 is held low, pulses on Input 1 are subtracted.

Signal I/P & Excitation

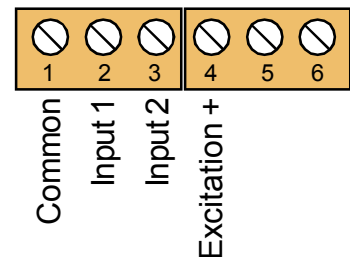

2 in. u.d. 2 in. u.u. 4 uudd 4 uuuu 4 dddd

Multi input, Up/Down totaliser

2in u.d. = Count up on input1, count down on input 2
 2in u.u. = Count up on input1, count up on input 2
 4in u.d. = Count up on input1&2, count down on input 3&4
 4uuuu = Count up on input1, 2,3 and 4
 4dddd = Count down on input1, 2,3 and 4

Signal I/P & Excitation

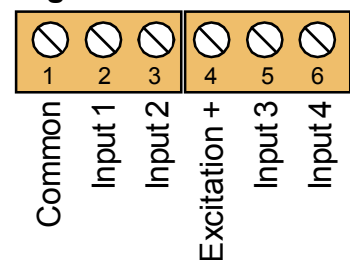

Production rate Mode

In this mode four inputs are available, two can add to give a combined total, and two can subtract to give combined rejects. This mode of rate measurement is ideal for showing real production rates over longer periods, for example showing items per hour, for the previous hour, updated every 15 seconds, 5 minutes, or whatever best suits your process.

1		<p>Lockout Switch must be OFF</p> <p style="text-align: right;">OFF</p> <p style="text-align: right;">Circuit board ON</p>
2		<p>Press to scroll through the available mode choices. Select 4 uddd. and press OK</p>
3		<p>PuLS in will appear, prompting you to enter a number of pulses, normally set to 1.</p>
4		<p>d.SP will appear, prompting you to enter a display value, normally set to 1</p>
5		<p>PrESEt will appear, prompting you to enter a number to start counting from. Normally set to 0</p>
6		<p>Pr.LoAd will appear, prompting you to enter a value to pre-load the counter with. Normally set to 0</p>
7		<p>b in.t will appear, prompting you to enter a value in seconds for the bin time. Default is 10. This is the display's update time in seconds. See opposite for a guide how to choose the best value.</p>
8		<p>b in.Cnt will appear, prompting you to enter a value for the number of bins to use. Default is 0, maximum is 200. See opposite for a guide how to choose the best value.</p>
9		<p>SCALE will appear, prompting you to enter a scale factor, to allow the readout to be presented in items per minute, per hour, per shift, per day etc. See opposite for a guide how to choose the best value.</p>
10		<p>Done!</p>

Application notes for Production rate Mode

1. Choose an averaging time, in seconds, you want to use for computing your production rate.

For example if you want to average over 45 minutes, your averaging time will be 2700 seconds.

We need to calculate an update time for your display, we will have up to 200 samples available in your averaging period.

Update time = $2700/200 = 13.5$
Round this up to the nearest whole number.
This is set in the variable **bin.t = 14**
Set **bin.cnt = 200**

This means that your display will update every 14 seconds in this case.

NB If your averaging time is less than 3 minutes, please use the formula
Update time = averaging time/20 , round up to nearest whole number = **bin.t**
Set **bin.cnt = 20**

2. We now need to set a scale factor so that your display reads correctly in items per hour, per minute or per second.



The scale factor settings will be....

For items per second = **SCALE** = $1/\text{bin.t}$
For items per minute = **SCALE** = $60/\text{bin.t}$
For items per hour = **SCALE** = $3600/\text{bin.t}$
For items per shift = **SCALE** = $28800/\text{bin.t}$
For items per day = **SCALE** = $86400/\text{bin.t}$

For an online calculator to choose the best settings for you, please see
<http://tinyurl.com/6cljcr6>

Quadrature Mode

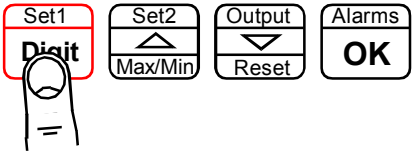
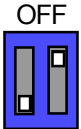
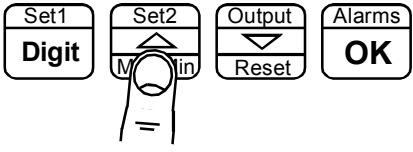
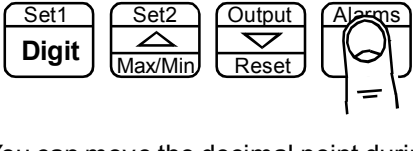
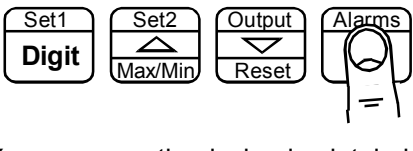
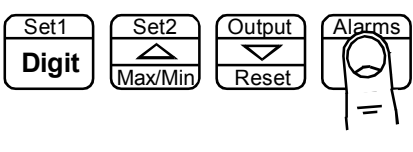
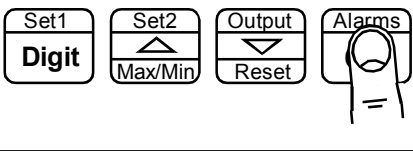
The quadrature mode allows you to scale a count and increase or decrease the value according to the sequencing of two pulses which are 90 degrees out of phase. This mode is ideal for measuring distance in pay-out/feed-in cable systems, or direction in rotary systems.

1	 <p>Press 3 seconds</p>	<p>Lockout Switch must be OFF</p> 
2		<p>Press to scroll through the available mode choices. Select QuAD and press OK to accept</p>
3		<p>PULS in will appear, prompting you to enter a number of input pulses, which will correspond to a desired display value. Use Digit, Up and Down buttons to set, and press OK to accept.</p> <p>You can move the decimal point during setting by pressing the UP button for a few seconds, then repeatedly press to shift the position.</p>
4		<p>DISP will appear, prompting you to enter a display value, which will correspond to the number of input pulses you entered. Use Digit, Up and Down buttons to set, and press OK to accept.</p> <p>You can move the decimal point during setting by pressing the UP button for a few seconds, then repeatedly press to shift the position. A negative value will give down counting.</p>
5		<p>PRESET will appear, prompting you to enter a reset value. The display will revert to this value whenever it is reset. Often used to count down from the preset to 0.</p>
6		<p>PRELOAD will appear, prompting you to enter a value, if required. You can preload a count number here. This value will disappear if you reset the display.</p>
7	 <p>Press to accept</p>	 <p>Done!</p>

Quadrature mode - application notes

In a quadrature sensor, the two incoming pulses overlap. Pulses to input 1 will arrive before or after pulses to input 2, depending on the direction of movement. This is achieved by staggering the trigger zones for sensor A and B. They must overlap, so that one will lead the other in one direction, and vice-versa. Trigger zones on large rotating wheels can be bolt heads or holes. In small angular encoders, the trigger zones are normally etched into a thin disc or are photographically produced to make light and dark areas.

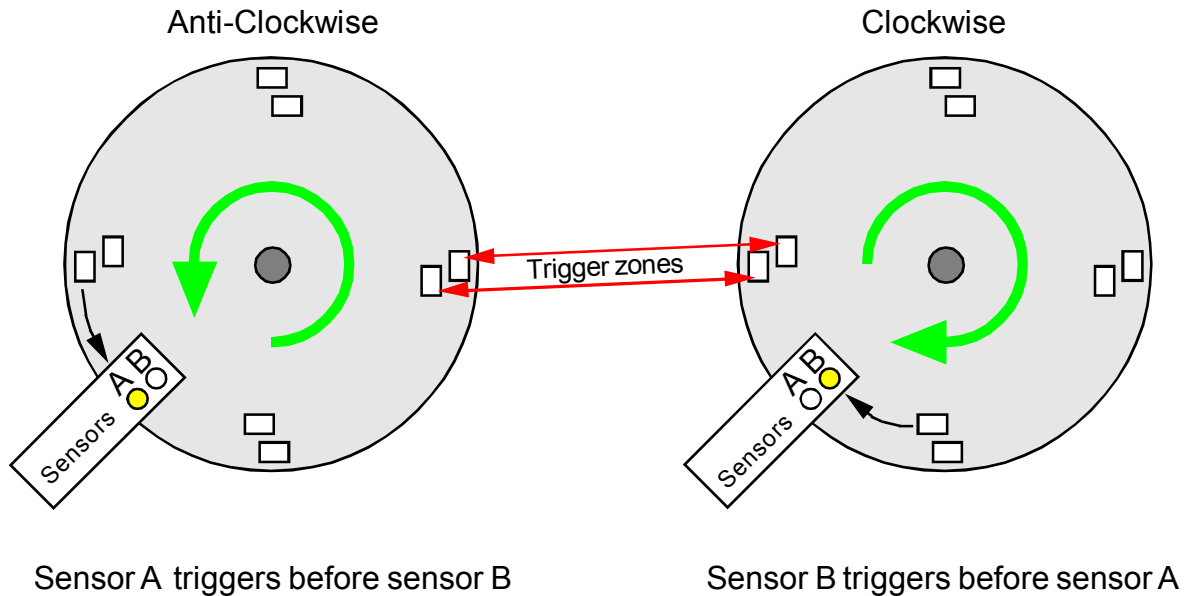

In the simplified arrangement shown above, we get 4 pulses per revolution, because we have 4 pairs of triggers. The angular resolution we get with this arrangement is 90 degrees. Some sensors have 1024 pulses per revolution, giving 0.35 degree resolution, but there are many different arrangements available. Our scheme above would be typical in cable laying applications, where it is more important to count revolutions of the drum than to know its absolute angle. The trigger zones can also be arranged in a straight line instead of around a circumference, to create a sensor for linear displacement.

Please be sure to check that the sensor's maximum output frequency is kept to less than 10 000 pulses per second.

QuAD

Quadrature counter

Pulses on input 1 are counted and scaled, with directional information decided by detecting whether pulses for Input 2 arrive before or after pulses for Input 1

Signal I/P & Excitation

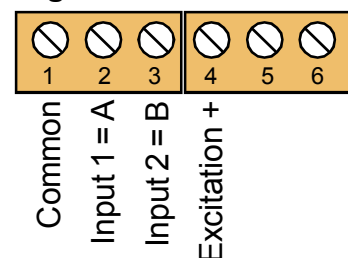

Logic input functions

The three contact closure inputs on the rear of the meter have default functions which are:-

- Contact closure 1 = Tare
- Contact closure 2 = Peak/Valley display
- Contact closure 3 = Reset

You can re-assign these to include :HOLD, Nett/Gross value display, Memory page address 1,2 or 4 (only if Multi-memory MEM option is installed)

1

Lockout Switch must be OFF

Press together briefly

Circuit board ON

2

Press repeatedly until you see **CC.1**, followed by the existing function for Contact Closure 1.

After you have set **CC.1**, you will get the prompt **CC.2** to allow you to set Contact Closure 2 function and when you have set **CC.2** you will get the prompt **CC.3** to allow you to set Contact Closure 3 function

3

Use UP or DOWN buttons to select from these available functions...

Defaults are:-

CC.1 = tArE	tArE = Tare display to 0
CC.2 = PU	PU = Peak/Valley toggle
CC.3 = rSt	rSt = Reset
	HoLd = Freeze display
	Net.Gro = Nett / Gross display
	PA.1 = Page Address 1*
	PA.2 = Page Address 2*
	PA.4 = Page Address 4*

4

Press to accept

Done!

* Only available if the Multi-memory MEM option is installed

Logic input connections and front buttons

The previous page explained how to select the functions of the 3 logic inputs. You can connect remote contact closures or open NPN collectors to activate these logic inputs.

The logic input provides a 5V DC signal. When you connect this to common, a current of 1mA will flow. Because this is a small signal, we recommend you use switches with gold plated contacts, or self cleaning contacts, for best long term reliability.

The logic inputs are not galvanically isolated from the input signal.

The logic inputs are only activated when the lockout switch is ON

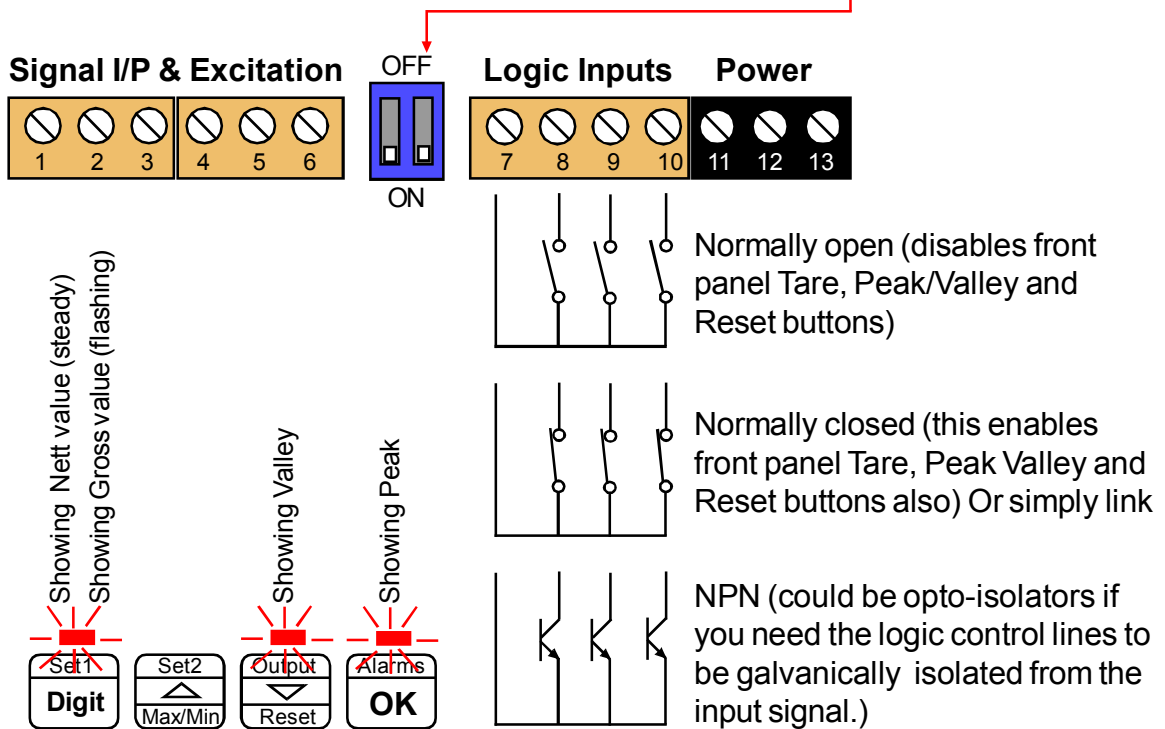

- tArE** = Tares display to 0. Often used in weighing systems to zero a display prior to making a measurement. Net weight is shown once tared. When a display has been tared the small LED above the Set1 button will be illuminated.
- PU** = Peak/Valley toggle. Allows you to view the maximum and minimum values which have been displayed since last reset. 0% LED illuminates when showing valley, 100% LED illuminates when showing peak.
- rSt** = Reset. This clears any tare, peak, valley, alarm latch
- Hold** = Freezes the displayed value for as long as the Hold input is closed
- nEt.Gro** = Allows you to toggle between Nett and Gross values on the display
- PR. 1 .. 4** = Page Addresses, if MEM option is installed.

Notes

Last Digit rounding up by 1, 2, 5, 10, 20 or 50

You can adjust the way the display rounds up, which is useful if you want to display a very large number, but do not want jitter on the last digit.

The display can be set to round up to the nearest 1 (no rounding) 2, 5, 10, 20 or 50

1

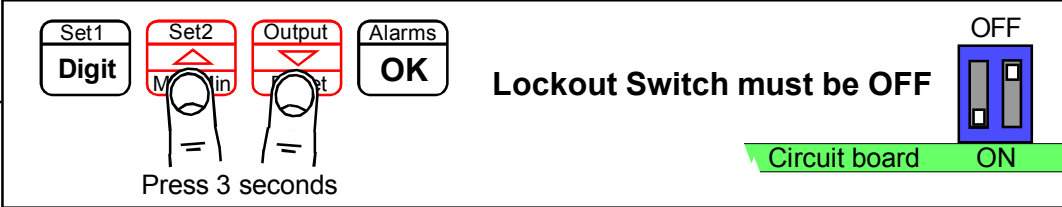

Set1 Digit Set2 Max/Min Output Reset Alarms OK

Press 3 seconds

Lockout Switch must be OFF

Circuit board ON

2

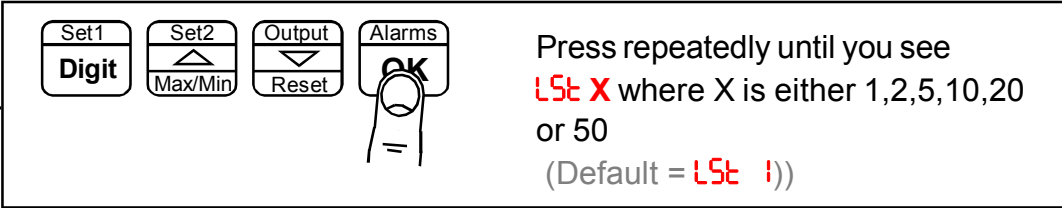

Set1 Digit Set2 Max/Min Output Reset Alarms OK

Press repeatedly until you see **LSt X** where X is either 1,2,5,10,20 or 50
(Default = **LSt 1**)

3

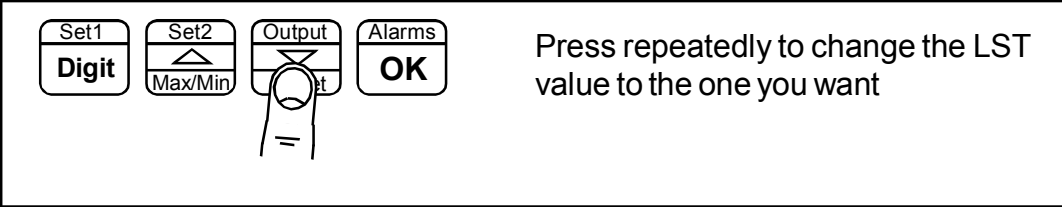

Set1 Digit Set2 Max/Min Output Reset Alarms OK

Press repeatedly to change the LST value to the one you want

4

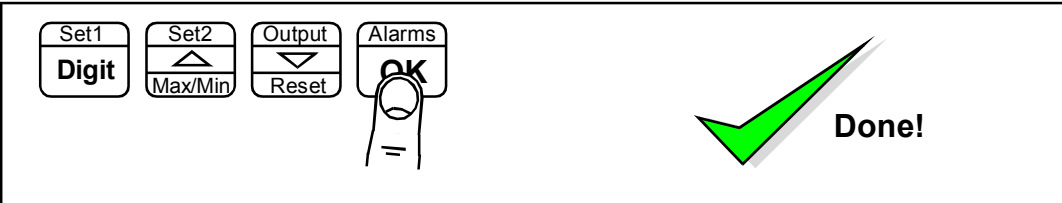

Set1 Digit Set2 Max/Min Output Reset Alarms OK

Done!

Scale Factor adjustment

After you have calibrated your meter, you can use the SCALE feature to make fine adjustments to calibration, without affecting the calibration itself.

Example

Changing volume units of measure from litres to Imperial gallons

You could also use the SCALE to convert your readout from litres to imperial gallons, without affecting the calibration. Simply set SCALE = 0.220 and your meter which was calibrated in litres will now read in imperial gallons.

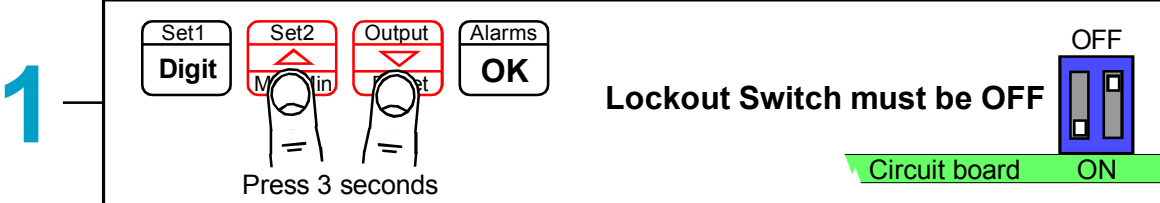
- 

1

Lockout Switch must be OFF

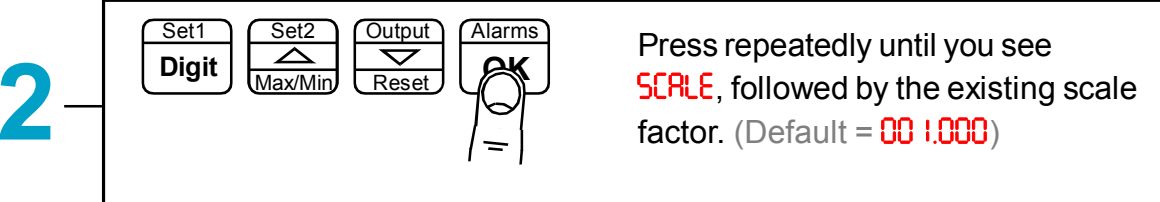
Circuit board ON
- 

2

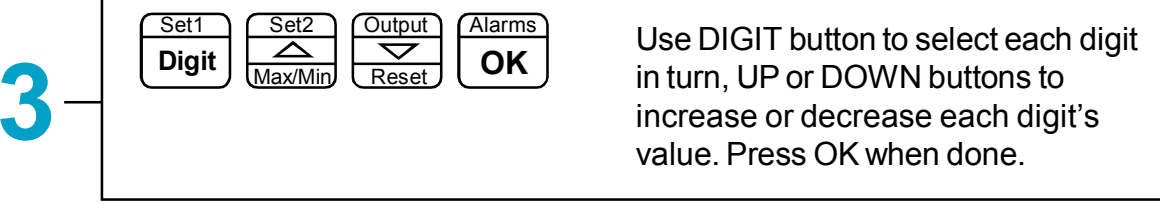
Press repeatedly until you see **SCALE**, followed by the existing scale factor. (Default = **00 1.000**)
- 

3

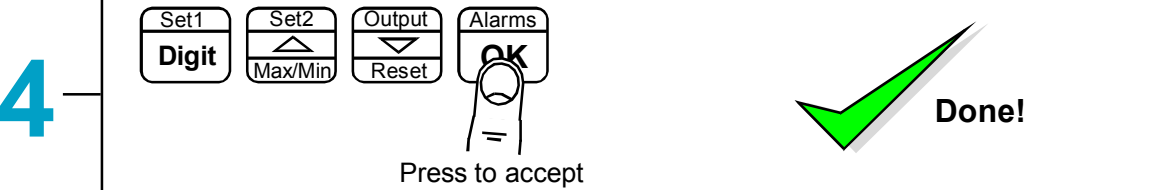
Use DIGIT button to select each digit in turn, UP or DOWN buttons to increase or decrease each digit's value. Press OK when done.
- 

4

Press to accept

Done!

You may want to adjust an offset value also, see separate OFFSET page for this feature.

Offset adjustment

After you have calibrated your meter, you can use the **OFFSET** feature to make fine additions or subtractions to the reading, without affecting the calibration itself.

1

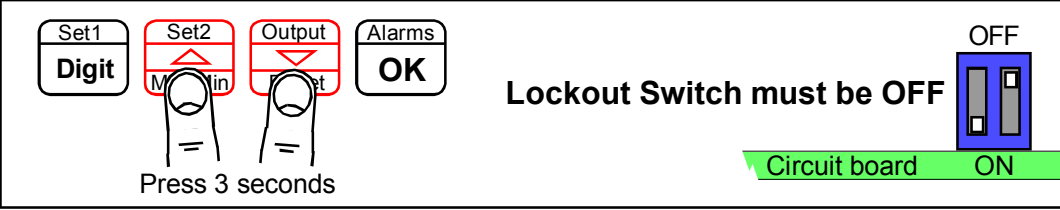

Lockout Switch must be OFF

Circuit board ON

Press 3 seconds

2

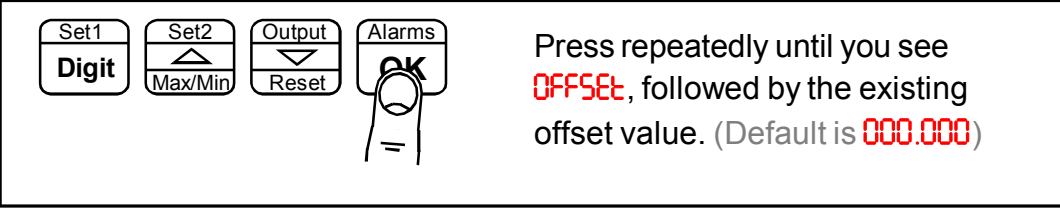

Press repeatedly until you see **OFFSET**, followed by the existing offset value. (Default is 000.000)

3

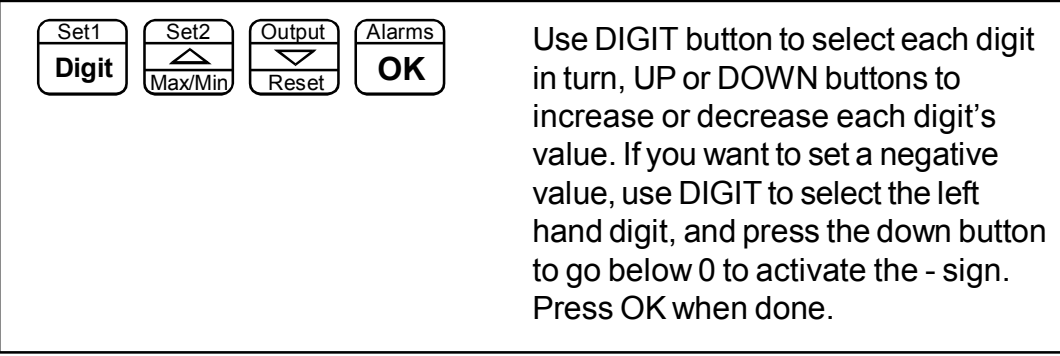

Use DIGIT button to select each digit in turn, UP or DOWN buttons to increase or decrease each digit's value. If you want to set a negative value, use DIGIT to select the left hand digit, and press the down button to go below 0 to activate the - sign. Press OK when done.

4

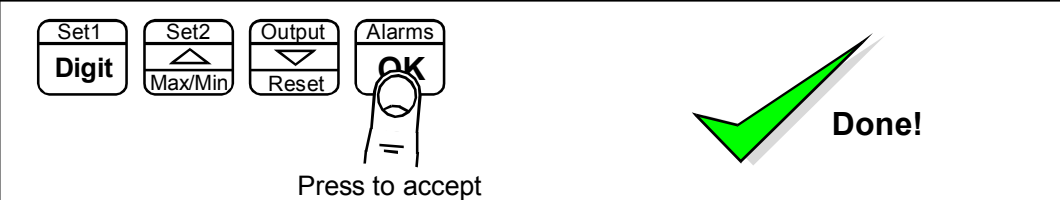

Press to accept

Done!

You may want to adjust a SCALE FACTOR value also, without affecting calibration. See the separate SCALE page for this feature.

Menu timeout adjustment

The display has a default timeout of 60 seconds, to allow you sufficient time to refer to the manual between key operations.

You can make this period shorter, if you wish, once you become more familiar with the setup method.

1

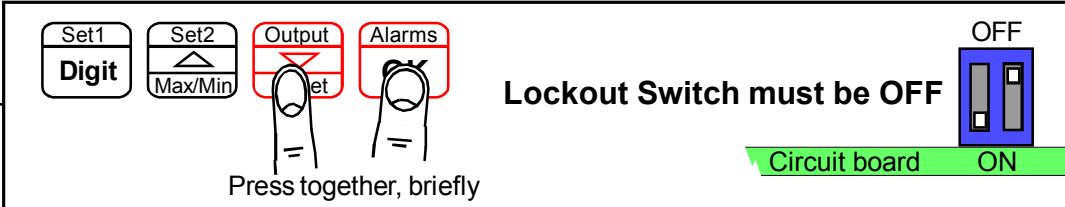

Press together, briefly

Lockout Switch must be OFF

Circuit board ON

2

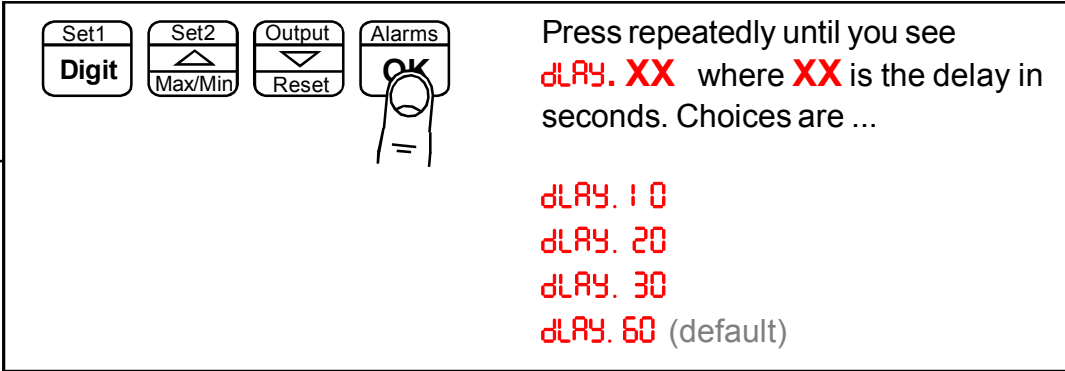

Press repeatedly until you see **dLAY. XX** where **XX** is the delay in seconds. Choices are ...

- dLAY. 10
- dLAY. 20
- dLAY. 30
- dLAY. 60 (default)

3

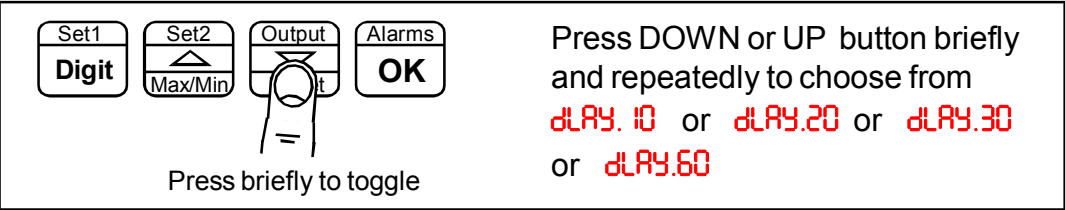

Press DOWN or UP button briefly and repeatedly to choose from

- dLAY. 10 or dLAY. 20 or dLAY. 30
- or dLAY. 60

Press briefly to toggle

4

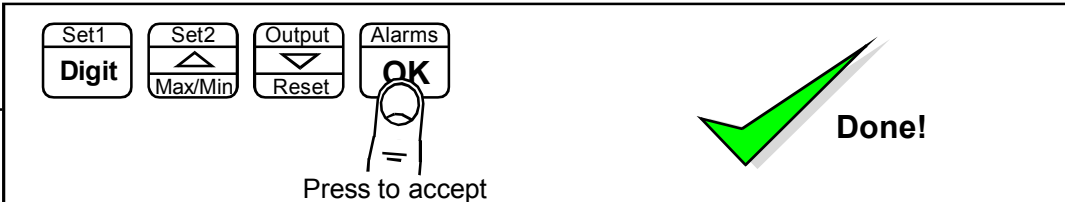

Press to accept

Done!

Reverse Display function (mirror image)

If you need to be able to see a reflection of the display in a mirror or other reflective surface, for example in a simple heads-up system, or for drivers reversing into a bay, using mirrors only, you can set the display to show as a mirror image.

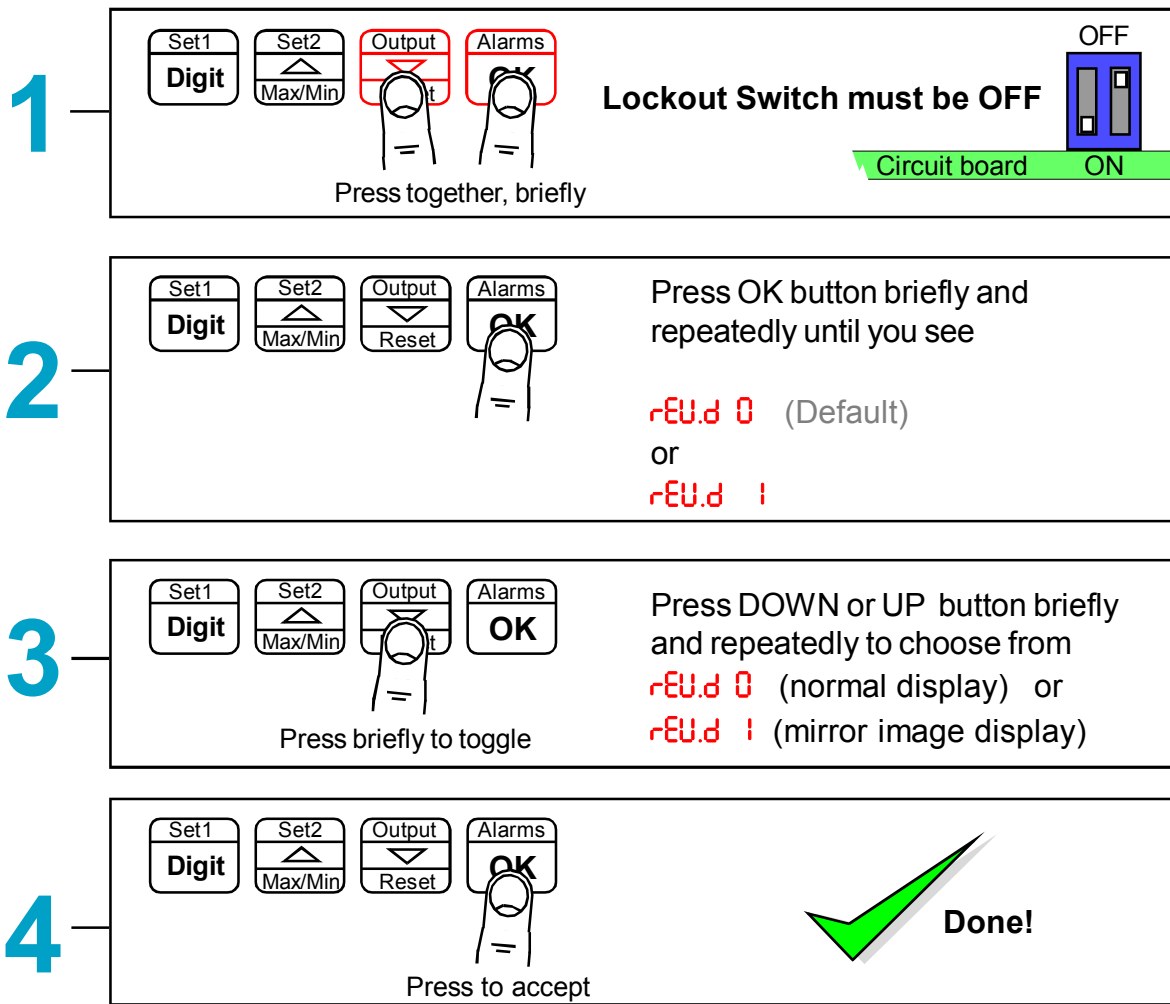

Example of normal display format displaying the number 876543



Example of Mirror Reverse display format displaying the number 876543

Bootup routine choices

When you switch on your meter, it can be set to power up with 3 possible summary message combinations.

The choices are:-

- boot 0** = Segment test, followed by a full summary of software revision, calibration audit number, model number, installed options.
- boot 1** = Segment test followed by model number (Default)
- boot 2** = No summary, meter displays the measurement value immediately power is applied.
- boot 3** = All segments illuminate permanently, until a button is pressed

1

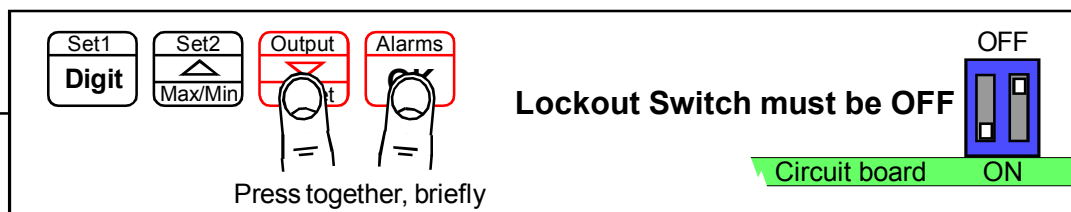

Lockout Switch must be OFF

Circuit board ON

2

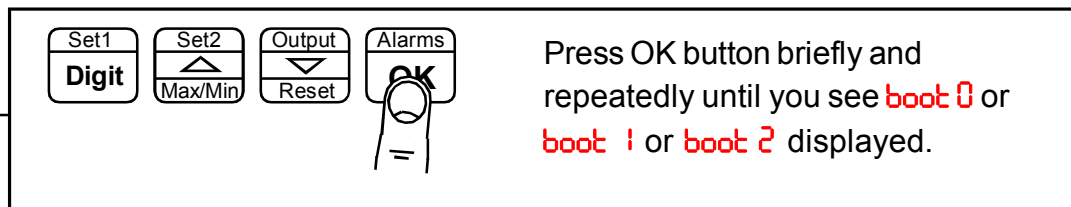

Press OK button briefly and repeatedly until you see **boot 0** or **boot 1** or **boot 2** displayed.

3

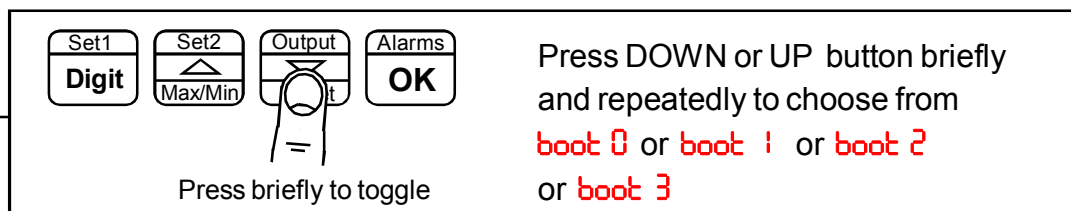

Press DOWN or UP button briefly and repeatedly to choose from **boot 0** or **boot 1** or **boot 2** or **boot 3**

4

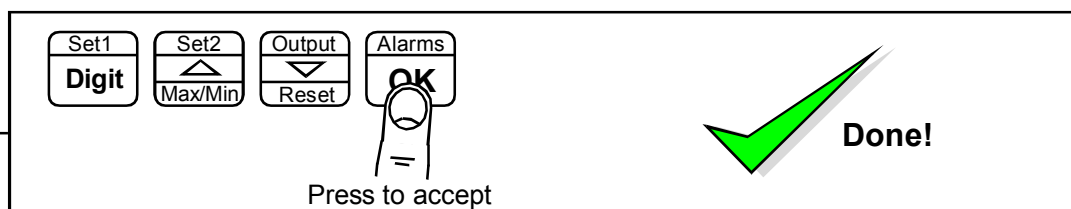

Press to accept

Done!



You can trigger the full summary message whenever you want, without having to power the meter off, by pressing and holding the 2 outer buttons (Set1 + Alarms) for more than 3 seconds.

Language Selection for user interface

You can select English or French menu prompts.

1

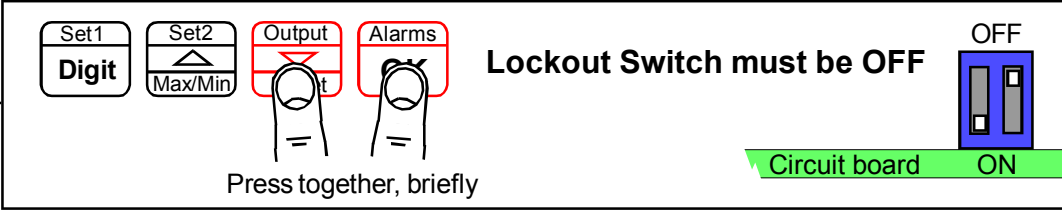

Set1 Digit Set2 Max/Min Output Alarms

Lockout Switch must be OFF

OFF

Circuit board ON

Press together, briefly

2

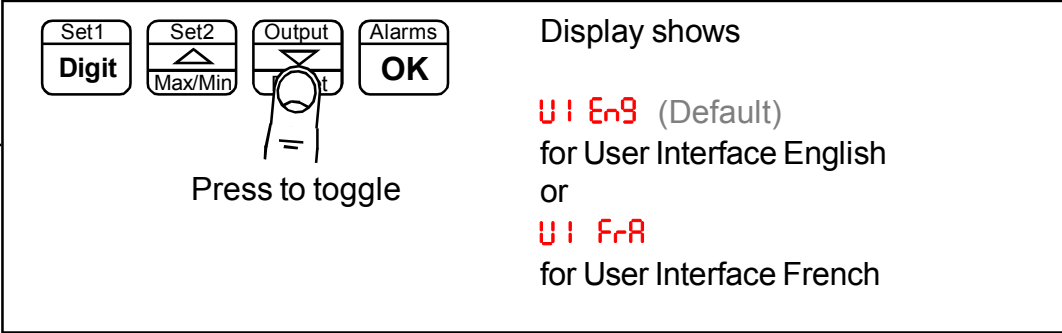

Set1 Digit Set2 Max/Min Output Alarms OK

Display shows

U1 En9 (Default)
for User Interface English
or
U1 FrA
for User Interface French

Press to toggle

3

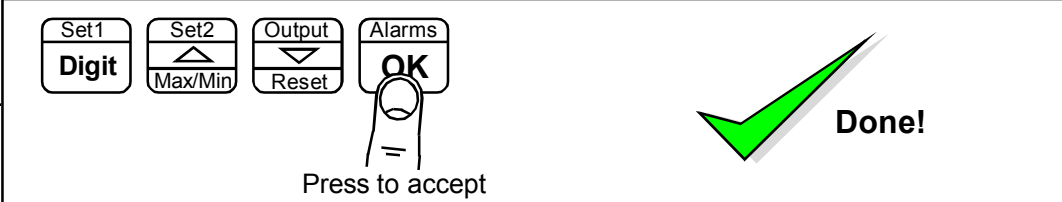

Set1 Digit Set2 Max/Min Output Reset Alarms OK

Done!

Press to accept

Multi-Program Memory option (Rate mode only)

The three contact closure inputs on the rear of the meter may be used to call up between 1 to 7 additional meter setup memories (pages), if the MEM option has been installed. This allows you to save up to 8 complete sets of independent calibrations, alarm settings, analogue output settings and serial comms settings.

First decide how many memory pages you want, as this will determine how many logic inputs you will need to use for the addressing. Logic inputs not required for Page Addressing can be used for other functions such as Tare, Reset, Display Hold, Peak/Valley display.

If you have used all 3 logic inputs for Page Addressing, you can still use the meter's front panel buttons to perform Tare, Reset and peak/Valley view.

See "Contact Closure Input Functions" page for CC.1, CC.2, CC.3 and COP settings

Total number of pages	Logic Inputs required for addressing
1	none, standard single page meter
2	1 Set CC.1 = PA.1
3 or 4	2 Set CC.1 = PA.1, Set CC.2 = PA.2
5 to 8	3 Set CC.1 = PA.1, Set CC.2 = PA.2, Set CC.3 = PA.4

1. Set lockout switches OFF, and set page address to 0 or unplug the logic connector.
2. Set the copy instruction to **COP. 1** in page address 0 (found after you set CC3) .
3. Press all 4 buttons together, display shows **dEFS.n**
4. Press the Up arrow to change display to **dEFS.y** and press OK.
5. If you want all channels to share a common setting, eg calibration, do that setting now.
6. When you want to do separate settings for each channel, set COP.0

Programming and recalling individual pages

Plug the logic input connector back in, if you removed it earlier. Select a page address using the switch combinations shown below, wired to the Logic Input connector ...

Page address 0	All logic inputs open
Page address 1	CC.1 closed to Common
Page address 2	CC.2 closed to Common
Page address 3	CC.1 and CC.2 closed to Common
Page address 4	CC.4 closed to Common
Page address 5	CC.1 and CC.3 closed to Common
Page address 6	CC.2 and CC.3 closed to Common
Page address 7	All logic inputs closed to Common

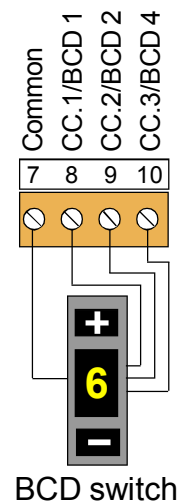

Perform the settings you require, according to the pages in this manual. Do this for all page addresses required. Then put the lockout switch in its ON position. Now, if you select a page address, the meter will briefly confirm the chosen page address on screen, and will then function according to the settings you programmed for that address.

Suitable BCD coded switches are available from many electrical supply stores. For example consider Kraus & Naimer part A540-600 E24 or Apem part number IRBC10N1248 or London Electronics part number SW2P-8W-BCD, which also provides separate 2 pole 8 way signal selection function.

Error codes and fault finding



1. Under Range. The meter is being asked to display a value which is more negative than its limit of -199999



2. Over Range. The meter is being asked to display a value which is higher than its limit of 999999

These fault codes could be displayed because the signal scale factor has been set too large or because the input frequency is too high.

3. Display is reading much higher than you expect and may also be erratic. This could be caused by contact bounce if you are using a contact closure input - be sure that the contact debounce is enabled dbnc.on

4. Total is not saved on power-down in a DC powered totaliser.

This could be caused by converting a DC powered INT2-P, INT2-L, INT2-S etc to an INT2-C. If you have converted one of these models to INT2-C, simply by changing the input board, you will find that total is not stored at power-down. You will need to fit a power-down control module, part number 9122-0401 to the display control board.

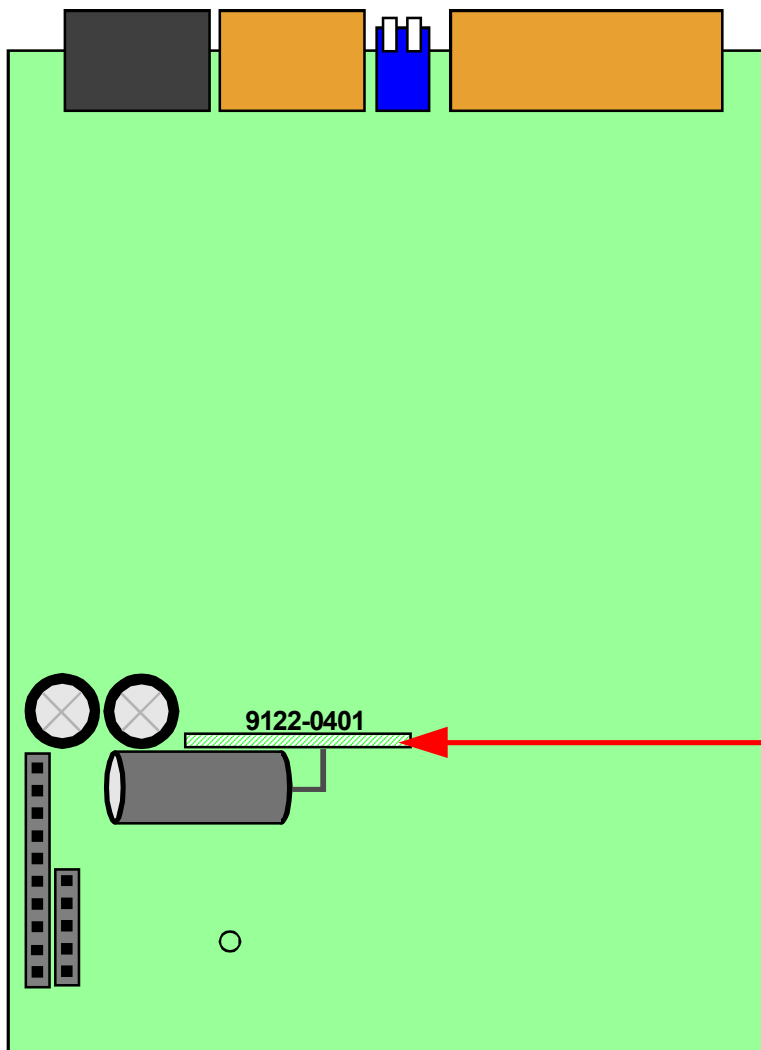

Location of the 9122-0401 board which fits in a slot in the main board.

How to install option boards



Where the product is intended for "UL" installations removal or addition of option boards is not permitted.



Warning: Disconnect power before you expose the rear of the meter

If you want to open your meter to install or modify option boards, follow these steps...

- 1) Switch off power to the meter and unplug all connectors.
- 2) Unclip the front bezel. This is easier if you squeeze the top and bottom of the case, near the front.
- 3) Remove the small screws shown in the diagram. If the meter doesn't yet have an output option board, the top screw may not yet be fitted.
- 4) Slide the electronic boards out through the front of the case. You can easily separate the upper option board from the main board. We strongly suggest that you use anti-static precautions to prevent damage to the semiconductors.

The board assemblies will look something like this...

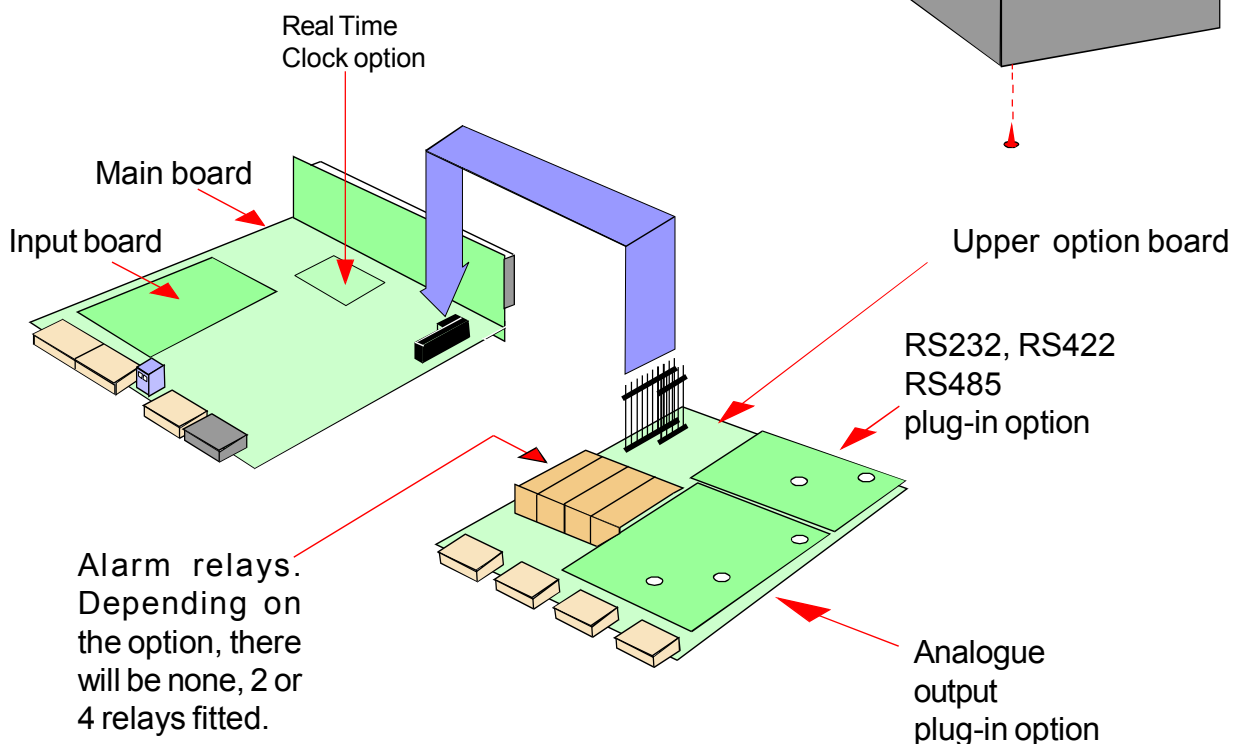

The analogue output and RS232 or RS422 plug-in option boards are fixed to the upper option board with white plastic pillars. You must apply a firm force when fitting or removing these options.

Always be careful to connect the pins to sockets accurately. When reassembling, make sure option boards are firmly fixed to the upper option board. When the boards are replaced in the case, secure them again with the two small black screws.

Waste Electrical Electronic Equipment (WEEE)

In Europe, this equipment must be disposed of in accordance with European Parliamentary Directive 2002/96/EC

This directive encourages recycling and the reduction of waste materials in the environment.

This means it must be sent to an approved recycling plant if you want to dispose of it.

It must not be thrown away with general rubbish.



WEEE Waste Recycling

If you are unable to dispose of this item locally, you may send it to us for recycling.

Conditions:

1. We will only accept items of our manufacture.
2. You must pay for the transport of the goods to us.
3. We will only accept items if they include a signed declaration by an authorised person in your organisation, stating that :-
 - i. The item is safe to handle and has no contaminants which may be harmful to health.
 - ii. You wish us to dispose of or destroy the item(s)

Equipment Specifications

Bezel size	48mm high by 96 mm wide (1/8 DIN)
Panel Cutout	45 mm high by 92 mm wide
Case Depth	125 mm including connectors
Weight	300 grammes
Case Material	Black polycarbonate
Connectors	Detachable Screw Terminal connectors
Environmental	Storage Temperature range -20 to +70C, non condensing Operating temperature range 0 to 50C, non condensing Front sealed IP65. Optional cover SPC4 for IP67
Power Burden	100-240 VAC, 45 to 60Hz or 11-30 VDC optional 10VA maximum
Input Signals (4x)	Contact closures, with debounce NPN and PNP proximity sensors (47kilohm pullup/down) 24V logic pulses from PLCs AC tachometer inputs 100mV passive Inductance pickup (on Input 1 only)
Frequency Range	0-40 kHz for total, 0-100 kHz on Rate, 9.5 kHz for quadrature absolute limit (38 000 edges/sec)
Accuracy (rate/frequ)	+/- 0.05% of range, quartz crystal reference +/- 20 ppm/Degree Celsius temperature coefficient Allow 30 minutes after switch-on, for thermal stabilisation.
Excitation voltage	24VDC nominal rated at 60mA, to power sensors (standard) 10V DC at 120mA Max (optional) 5V DC at 30mA max (optional)
Averaging / smoothing	Selectable averaging time constant of 0 to 25 seconds. Production rate monitoring is adjustable and can be averaged over a full day.
Memory	Totals and settings saved in 10 year non-volatile memory.
Display update rate	3 readings per second for rate, 10 readings per second for total
Display Range (max)	-199999 to 999999

Plug-In Output Options

Details are presented in each individual manual for the analogue, alarm and serial communications options, available from our website, or supplied with the option itself.

Record of Revisions

1 May 2016

INT4 series Released

Declaration of CE Conformity

Declaration Reference : INTUITIVE Mk2
Issue Date : 30 April 2007
Products Covered : INTUITIVE Mk2 series
Title : DOC-INTUITIVE2

This is to confirm that the Product covered by this declaration has been designed and manufactured to meet the limits of the following EMC Standard :

EN61326-1:1997

and has been designed to meet the applicable sections of the following safety standards

EN61010-1:2001



Conditions

The meters are permitted a worst case error of 1% of A/D range during electro-magnetic disturbance, and must recover automatically when disturbance ceases without the need for human intervention, such as resetting, power-down etc.

The meters covered by this certificate must be installed in adherence to the following conditions :-

Signal cabling shall be routed separately to power carrying cabling (includes relay output wiring)

All signal cabling shall be screened. The screen shall only be terminated to the power earth terminal at the meter end of the cable.

Declared as true and correct, for and on behalf of London Electronics Ltd.

J.R.Lees Director

We design and manufacture a wide range of standard and custom monitoring and control equipment.

All our UK manufactured products have a 3 year warranty.

Real-Time Production-Line Displays

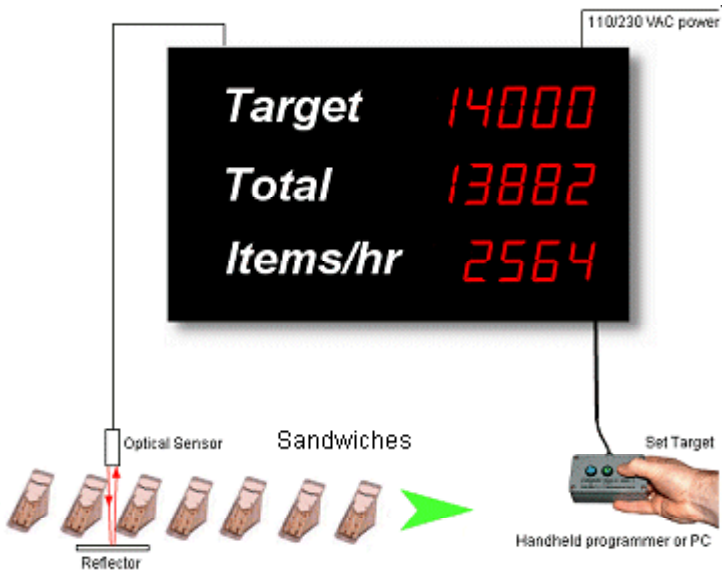

Large Digital Displays sealed IP65



Digital Panel Meters



Power Monitors



Bargraph Displays



Message Displays sealed IP65

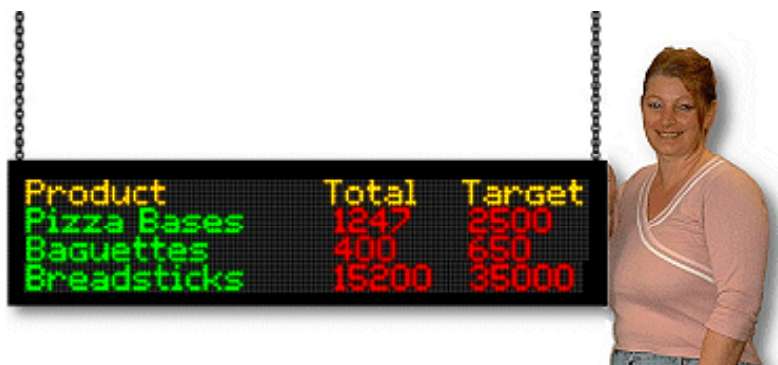

Signal Transmitters / Isolators

